



ECO ARBOR DESIGNS

Structural Wood Pavers

Structural Hardwood Deck Tiles

IMAGINE A DECK OF YOUR DREAMS BUILT IN ONE DAY.

OUR PREMIUM STRUCTURAL DECK TILES WILL INSTANTLY TRANSFORM YOUR OUTDOOR LIVING SPACES.

“The most elegant yet durable outdoor flooring ever created.”

– Dwell Magazine

ECODECK Hardwood deck tiles are the most durable and cost efficient decking systems available for roof tops and patios. Made of solid and eco certified 5/4th" Ipe deck boards and strong under bracing fixed with german stainless steel screws. Our unique manufacturing design ensures a 40+ year lifespan and an outdoor floor that will age with distinction. ECO deck Ipe pavers by Eco Arbor Designs are can be used for any rooftop or ground level decking application, commercial or residential. Install on pedestal supports, wood joists or fixed height deck tile connectors directly over your patio surface.



EcoDeck™ Structural Hardwood Deck Tiles

Can be used for:

- Building elegant and refined creative rooftop decking environments
- Urban patios, terraces and rooftop decks.
- Commercial or residential flat rooftop terraces and plazas
- Decks on green roofs or any surface where you don't want a built up deck with limited access. A modular tile system creates easy access to the roof surface
- Residential decks over cracked concrete patios or uneven surfaces
- Decking and landscaped areas on street and curb sides
- Commercial walk Decks, restaurant patios, residential decks and retrofitted decks

Deck tiles are a perfect square or rectangle and are easy to remove. Irrigation or electric conduit, recessed lights can easily be run underneath to your planters with our structural wood pavers. Pre-assembled Wood Deck Tiles are built with select cut Grade A Hard woods Bolivian ABT Certified genuine hardwood. Ipe, and Garapa wood available. Marine Grade Stainless steel deck screws used in assembly of each tile. Stock sizes include 2x2, 2x4, 2x6, custom sized tiles available on request.

EcoDeck™ Ipe 2x2 Structural Deck tiles installed over roof membrane. Installation is easy and efficient. Structural deck tiles can be removed in sections or entirely from the surface to provide easy access to the sub surface for future maintenance. This makes maintenance easy and affordable. ECO deck structural deck tiles have an incredible durability rating of 20+ years. Being that they are light-weight and carry such a high durability rating it is no wonder that they are rated the number 1 decking material by designers and architects across the globe.

EcoDeck™ Structural Deck tiles ship from our facilities in NJ and CA locations. Our product is hand loaded and secured on pallets for easy transit



This is how our structural deck tiles will arrive at your door

each pallet is loaded with 50 tiles with banding and wrapping to eliminate the chance of damage during transit.



EcoDeck™ 2x4 Structural Ipe Deck Tiles

Location: Venice, Ca Contractor: Kevin Cities Contracting

EcoDeck™ Structural Deck Tiles

Sizes and Wood Details

Dimensions	24" x 24" x 1-11/16" 24" x 48" x 1-11/16" (custom size)
Smooth	Smooth
Weight	22.5 5.75 lbs. per sq ft very light weight!
Fire Rating	Class A (ASTM E108-07a Spread of Flame)
Hardness	3680 lbs. (Janka rating)



Ipe

Botanical name:	Tabebuia Serratifolia
Family name:	Brazilian Walnut
Other names:	Pau Lope, Diamond Decking, Ironwood
Janka hardness:	3680
Specific gravity:	.89
Modulus of Elasticity:	24900 N/mm(2)
Crushing Strength:	8690psi
Static Bending:	22560psi

Ipe is an uncommonly strong, exceptionally durable hardwood found primarily in Brazil, with smaller and more sustainable volumes available from Bolivia. Although Ipe is not easy to work with, it dresses well, but it requires good tools due to its hardness. It is stable and warp-resistant, with a fine to medium texture. Ipe has excellent screw-holding capabilities when pre-drilled. Ipe has wide range of applications; it is often used for industrial and decorative flooring, carpentry, naval construction, hydraulic works, tool handles, exterior joinery, decking, siding and many other purposes. Ipe was rated one of the best decking products for durability and longevity typically lasting over 40 years in North American climates. Ipe is so dense it is considered CLASS A with ASTM ratings. It is also termite proof with no living insects able to penetrate the lumber.



Garapa

Botanical name:	Dipteryx Odorata
Family name:	Brazilian Ash
Janka hardness:	3240
Specific gravity:	.92
Modulus of Elasticity:	25700 N/mm(2)
Crushing Strength:	8400psi
Static Bending:	27380psi

Its golden color, fine grain and moderate cost make it an attractive alternate to more expensive hardwoods such as Teak or Ipe for decking. Garapa used in the past for docks and piers, railroad ties, flooring, decking and many other purposes where a heavy duty weather resilient hardwood is needed. Garapa is also a very fast growing sustainable species. One of the main reasons we at Eco Arbor has chosen this species for deck tiles. Our 20 year experience in wood pavers we find it stable, hard wearing and just as durable as Ipe. Its heartwood is beige to light-brown sometimes a rich beige brown. Garapa is a coarse-textured, very heavy wood that is hard to work with but finishes quite smoothly. Eco Arbor builds these tiles with the finest grade of Garapa. This wood does not carry an ASTM rating like Ipe carries a Class B fire Rating.

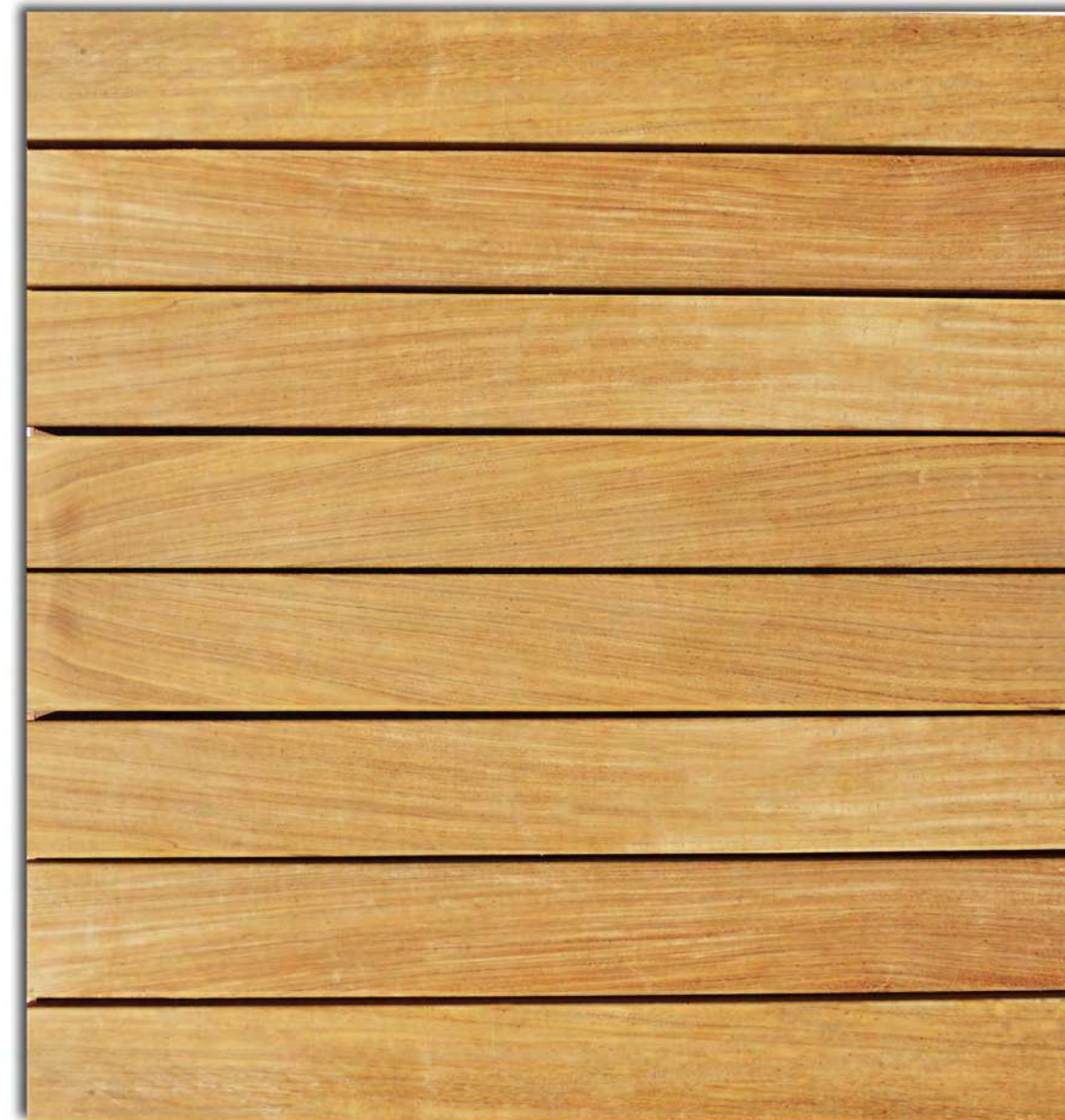

Sustainably sourced Hardwoods

1) All of the hardwoods we purchase to produce our hardwood products are harvested in accordance with the Bolivian Governments sustainability forestry program. The ABT Forestal is the Bolivian agency of forests for private land logging. All of our lumber has this sustainable stamp of approval and has proven to be one of the most stringent sustainable forestry operations in the world. This program is endorsed by the Nature Conservancy, World Wildlife Fund and the Rainforest Alliance among others and is a genuine sustainable forestry program. It is now endorsed by environmentalists across the globe as Bolivia is leading the sustainable forestry front. We believe this program that supports small sustainable logging operations is far better than the larger scale operations endorsed by the FSC in Brazil and other South American countries where widespread deforestation is commonplace and corruption is commonplace in the logging world.

2) The efficiency and longevity in using genuine hardwood lumber as opposed to softwoods such as redwood or cedar. We buy the shorts and make a beautiful product with wood that would typically be discarded or sold for charcoal production. When comparing our tiles to traditional deck building the lumber use is about half for the same floor coverage. The difference between conventional decking and Eco Decking Tiles, in terms of USAGE of timber is vast: For 100 m² of decking, conventional decking uses in terms of area a total of 100m², our product has a 5-mm gap between each wood slat, therefore in terms of area, it uses 92.32 m² of timber. However in terms of volume, there is an even larger difference, for 1" thick conventional decking, the total m³ used for the same 100m² of decking is 2.54 m³, because our product uses a 15-22mm thick lumber, the m³ usage of timber is 1.04m³ far less lumber for the same coverage. Nothing is compromised in quality or looks for using less lumber. The overall benefit is a deck that will last 40 + years, to one that will last 10-15.

3) Products that are re-usable are green in our opinion. More than likely our decking tiles can be reclaimed and reused in our lifetimes. This is a term used for materials that do not go to a landfill once used for many years but rather can be picked up and used elsewhere. Our tiles can be removed, resurfaced and relocated to your new home or project or used for paneling or cladding. This not only protects your investment in the material but ensures future use of the material in another living space in the future. The hardwoods we use will never rot and can always be used again for decking, siding or cladding.

4) Bottom line is carbon footprint, even after our product has traveled the world to arrive on your project site, the longevity, the re-usability and the fact this material prevents the existing surface from being removed makes up for the energy used to get the material to you. We have removed old Ipe decks to re-purpose the lumber for interior flooring or rustic siding. Just look at the Atlantic city boardwalk. Ipe was used to create this magnificent boardwalk over 50 years ago, last year it was finally removed and flooring companies all over the country clamored get a piece of it only to re-finish the wood and use it for interior flooring. Some of this flooring was sold at over hundred dollars a sq ft and today sits in homes across the country to be used for the next 50 years. Now that is long term use



EcoDeck™ Structural Deck Tiles

FINISHES

Our deck tiles are designed for constructing raised wood decks over exterior surfaces such as rooftops, terraces and plazas. Our hardwood tiles are constructed from Kiln dried 1x3" wood face slats secured to 3 Ipe wood support runners (battens) using marine grade stainless steel screws. This combination makes for a high structural strength and dimensional stability and no flexing surface. EcoDeck™ Structural Tiles are an elegant yet extremely durable solution for roof decking and elevated flooring. Tiles are designed to be used on pedestal supports but can be installed over joist framing and traditional decks. Either let patina to silver gray, or apply an oil penetrating sealer to enhance color.



Weathered

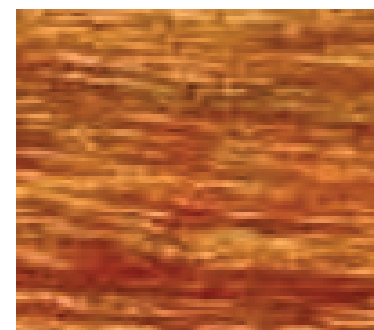

Waxed

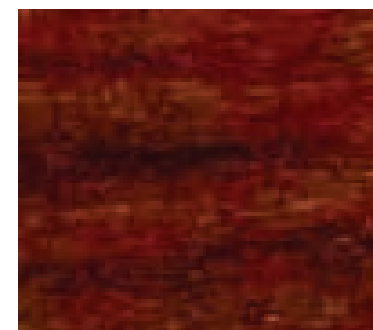

Varnished



Seled or Weathered

Ipe Deck Tiles can be sealed to maintain its natural beauty or it can be allowed to weather to a beautiful silver gray. To retain the rich color, an oil based finish with ultraviolet inhibitors is recommended.

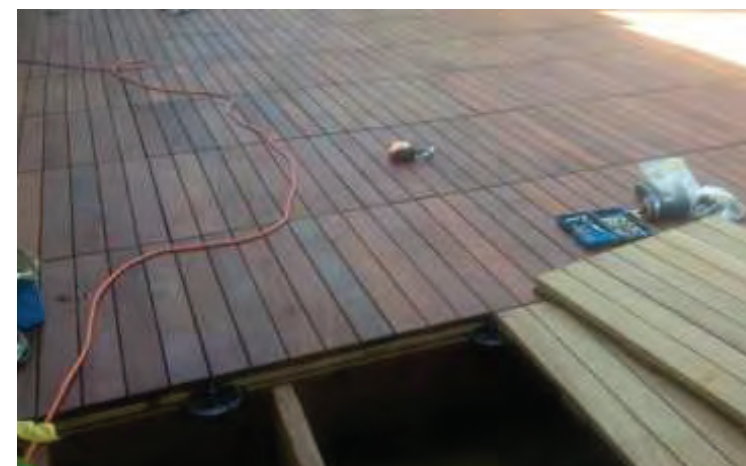

Smooth Surface

structural Ipe Deck tiles is our most popular tile and exceeds the Americans with Disabilities Act requirements for Static Coefficient of friction in a wet environment (ASTM-C1028-89)



Grooved Surface

Structure Ipe Deck tiles provide the highest slip resistance for wet climates. Often specified when added slip resistance is desired but not required.



Structurally

constructed with 7/8" thick boards for extra strength and resistance to flexing. A slot cut in the corner of each tile enables a special washer to be inserted and invisibly screwed to the top of the pedestal, thus locking down the tiles and ensuring a safe, secure and level surface.

Telescoping Paver and Deck Supports

by Eco Arbor Designs

Our Wood deck Pavers can be elevated over the surface a number of ways, either by using our telescoping pedestal supports, our hybrid PVC based pedestal or our fixed height deck tile connectors. A solution exists for every surface and no one pedestal system solves them all

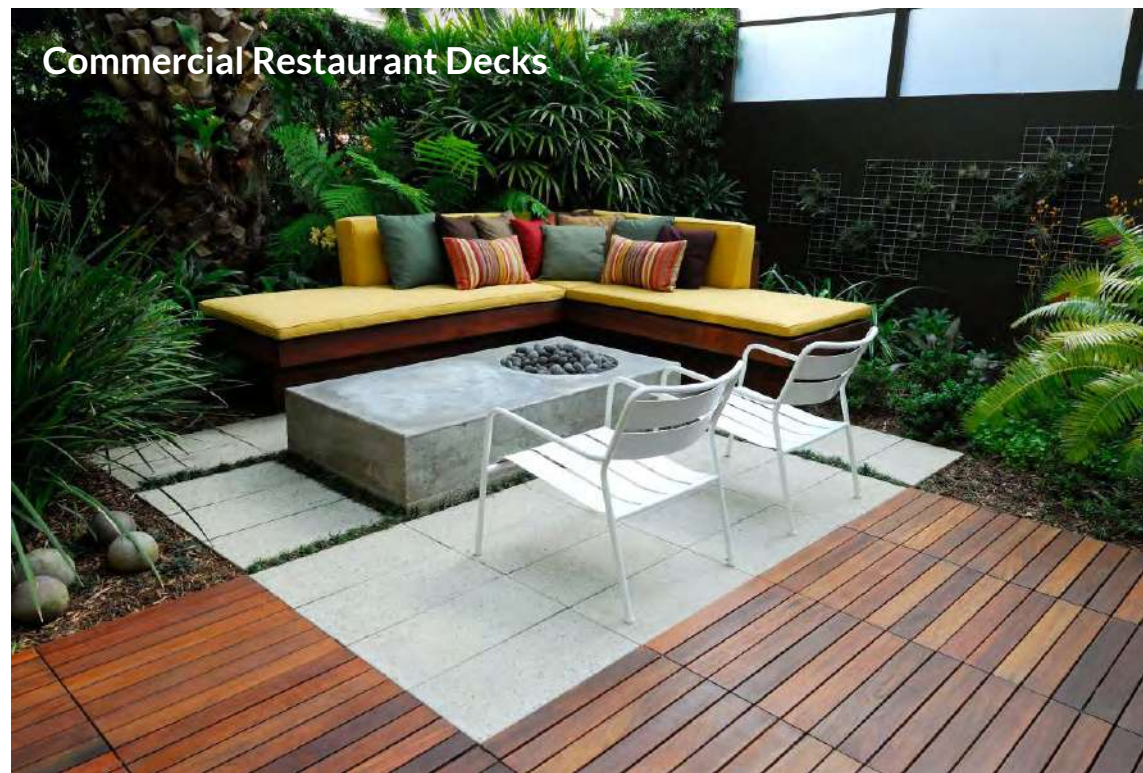

deck tile connector on grade



over telescoping pedestal



Hybrid PVC pedestal





EcoDeck™ Pedestal Specifications

Height range:	3" to 6" (extneders can increase to 40" or anything below)
Color:	Black
Dimensions:	Head diameter 6.3" Base diameter 8.1" Extender height 3"
Compressive strength:	>3527.4 lbs.
Slope compensation:	5.94" onwards with Extenders1 – 4.4" per extender 1 additional heights possible with bracing system 0% to 5% @ 1%increments
Weight:	~ 1.54 lb. per unit
Crushing Strength:	8690psi
Service Temperature:	-20 C to 120 C Unaffected by molds and algae and good resistance to alkali and bitumen
Material:	Recycled Polypropylene Extender ~ 300 grams per extender VJ Bearer Holder For 50mm to 75mm width 2 compression strength varies with different heights.



EcoDeck™ Pedestal Installation Methods

- Use sight or laser lines to mark the intersections of the corners of each deck tile to be laid. A layout can be chalked on the surface before installation begins to understand your perimeter cuts.
- Position Pedestals across surface. Adjust the 0% to 5% slope corrector to compensate for any fall in the surface.
- If necessary, saw along marked score lines on the base so that the units may be positioned along wall edges or in corners. Cutting the tiles can be achieved by removing the bottom brace, making the cut and re-attaching it to the underside of the tile.
- Position the wood first paver in a corner and subsequent pavers along a wall edge. move your way across the surface making sure each tile is level to the adjacent.
- Place pavers or wood panels on VersiJack® 75, or spirapave pedestals and simply adjust either up or down to obtain level required. Use rubber shims, if required to micro adjust the corners of each tiles to ensure that the finished surface is level
- Place each tile over the pedestals starting with your first complete tile in the corner, adjust pedestal as necessary placing the tile on the plug of the deck tile connector.

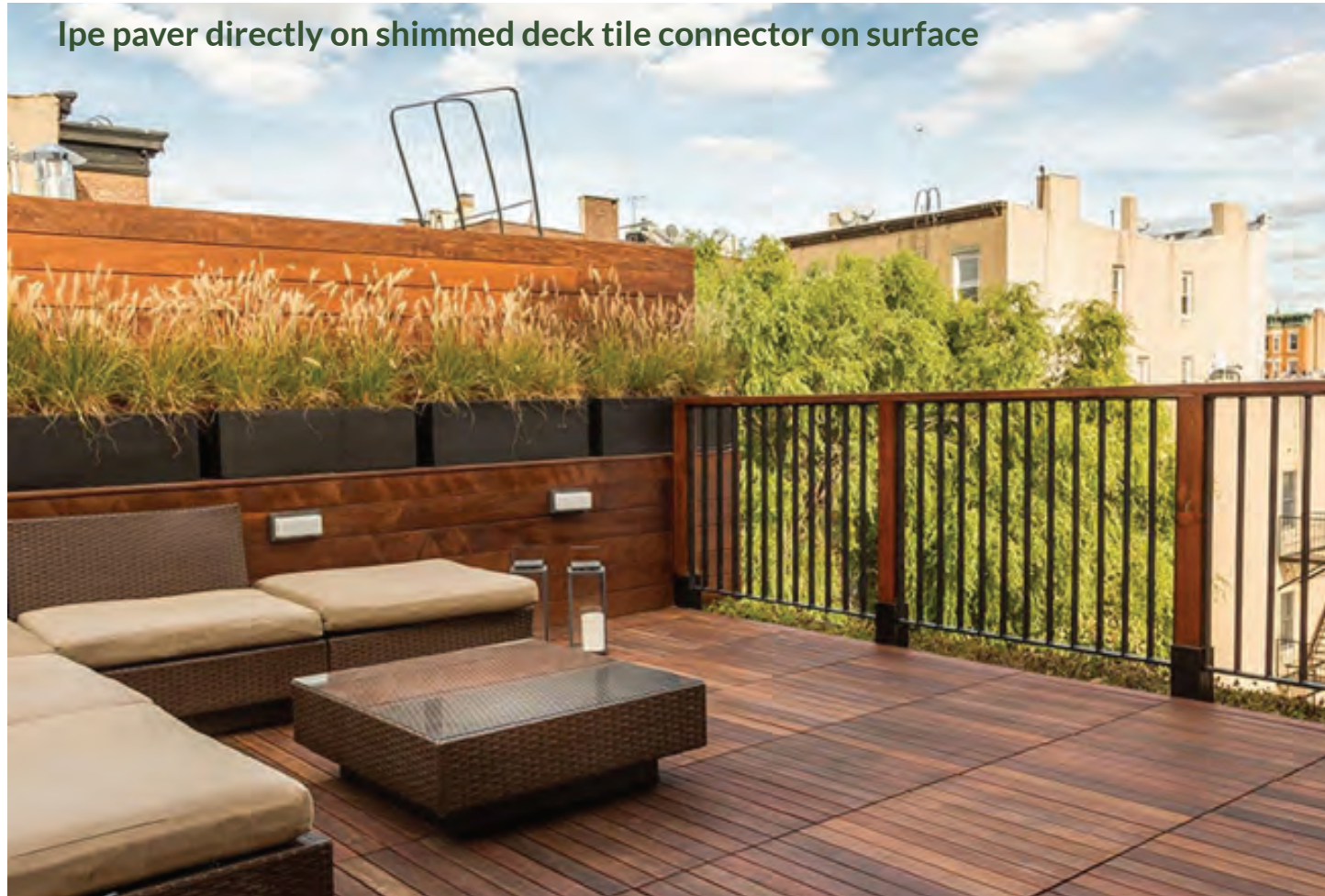

EAD Pedestal Height Chart

EAD-0	EAD-1	EAD-2	EAD-3	Extender
3/4"-1.25"	1.5"-2.55"	2.5"-4"	3.5"-7"	6" extender



* Optional base Slope corrector adds 3/4" to height of each pedestal

Spacer Tabs

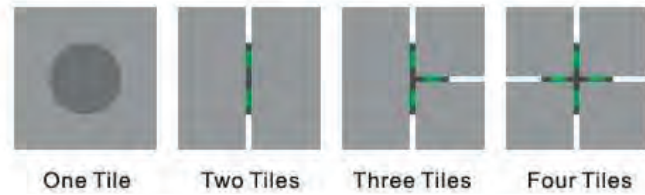
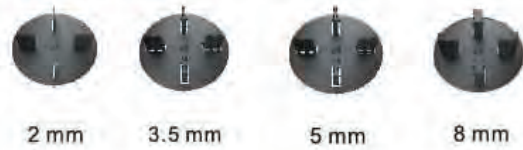

Joist Cradle

Fit any joist width 20-80mm



Deck tile connector and support



Base Rubber Pads

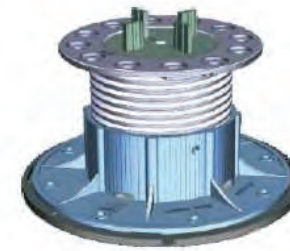

Anti-noise silent base rubber pads

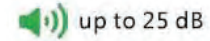

up to 25 dB

Base Slope Corrector

Slope Corrector allows slope of 0-5%

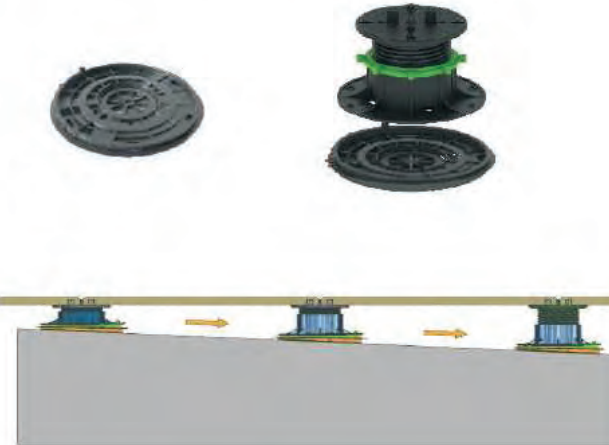

15mm extending pad

One basic pedestal + Extending pad (s)
Simple combination, one size pedestal solve all problem
Easy to keep stock



Wallside buffer steel clip and side closure steel clip

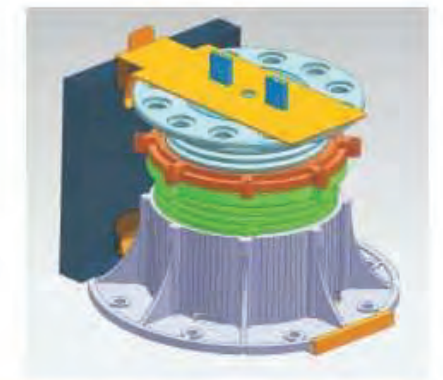
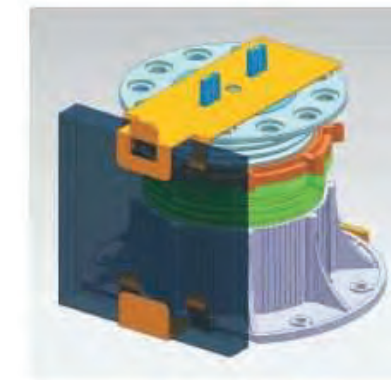

PAVER / DECKING SUPPORT PEDESTAL

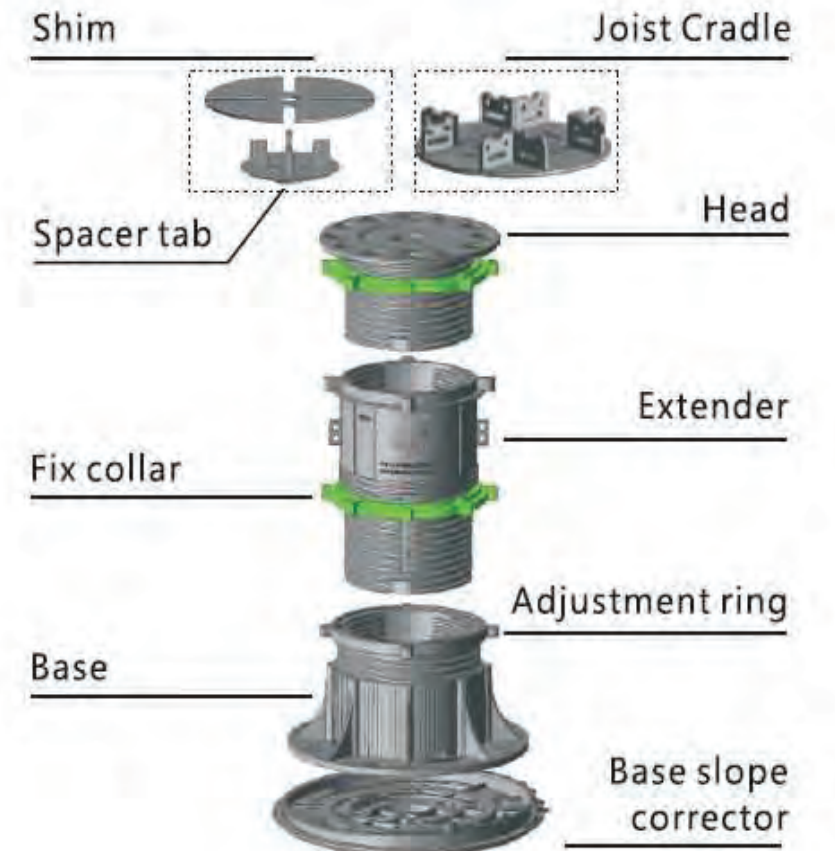



Eco Arbor Designs Deck Tile / Pedestal Sheet

EAD Deck Tile Spec Sheet A. General Deck Pedestals and Wood Tiles Information

1.1 Summary

A. This Section includes the following:

- 1.** Unit paving on adjustable pedestals installed on sloped roof decks, patios or any sloped outdoor area requiring Elmich pedestal supports.
- 2.** Monolithic, reinforced rubberized asphalt membrane and associated protection course, flashings, extruded-polystyrene insulation, and drainage course.

1.2 Submittals

A. Submit in accordance with Division 01 Section "Submittal Procedures."

B. Product Data for each type of product and material used can be supplied as well as full take off service for number of pedestals.

C. Shop drawings: Indicate perimeter conditions, relationship to adjoining materials and assemblies, joint layout, installation and details.

D. Certification: From an approved independent testing laboratory experienced in testing this type material, that the material meets the CGSB-37.50-M89 standard for rubberized asphalt membranes, including applicable ASTM procedures.

E. Samples for wood tiles, 2cm porcelain tiles, and Stonedek tiles and pedestals, and accessories:

1. Submit three (4) representative samples of each wood tile. Select samples to indicate full range of color and texture expected in the finished installation.

2. Accepted samples become the standard of acceptance for the work in this Section.

F. Warranty: Sample of warranty specified in this Section, each product carries a slightly different warranty based on type of material.

1.3 Quality Assurance for installation

A. Installer Qualifications:

1. The deck support system installer must have a minimum of two (2-4) years proven construction experience, be capable of estimating and building from blueprint plans and details, determine elevations, and properly handle and deliver materials. All Work must comply with the EAD installation application procedures for deck support work specified herein.

B. Special Considerations:

1. The contractor assumes the responsibility for and must take into consideration the structural capability and adequacy of the structure to carry the dead and live load weight(s) involved, and that the density of any insulation is satisfactory to resist crushing and damaging the waterproofing membrane.

C. Mockups:

1. Install a 4 ft x 4 ft area, include full range of colors and textures, borders, and designs.
2. Use this area to determine pedestal height and shimming requirements, and joint sizes.
3. Mock-up will be used as the standard by which the work will be evaluated.
4. Subject to acceptance by owner, mock-up may be retained as part of finished work.

Eco Arbor Designs Deck Tile / Pedestal Sheet

EAD Deck Tile Spec Sheet A. General Deck Pedestals and Wood Tiles Information

1.4 Delivery, Storage, And Handling by EAD and customer

- A.** Comply with Division 01 Section “Product Requirements.”
- B.** Comply with manufacturer’s ordering instructions and lead-time requirements to avoid construction delays.
- C.** Deliver materials in manufacturer’s original, unopened, undamaged containers packaging with identification labels intact.
1. Coordinate delivery and paving schedule to minimize interference with normal use of building adjacent to paving.
 2. Deliver wood tiles to the site in steel banded, plastic banded or plastic wrapped packaging capable of transfer by forklift or clamp lift.
 3. Unload wood tiles at job site in such a manner that no damage occurs to the product.
- D.** Protect stored materials from mud, dirt, and other foreign materials
1. Store cleaners and sealers in accordance with manufacturer’s instructions for storage of said product.

1.5 Project Environment

- A.** There are no pedestal installation temperature restriction guidelines other than the practical considerations of working in any unsafe condition or inclement weather.
1. Do not install membrane when the ambient temperature is below 0°F.
 2. Do not allow petroleum, grease, oil, solvents, vegetable or mineral oil, animal fat, etc. to come in contact with the waterproofing membrane, this includes deck tile sealers.
- B.** Deck supports specified are to be for used with pedestrian traffic only.
- C.** Pedestrian decks must be restrained by perimeter blocking or walls on all sides. Lateral movement greater than 1/8” is unacceptable and will be rejected.





D. Heavy Roof Top Features. Flat bottom features such as planters, heavy benches, water features, hot tubs, etc. always require individual support that is in addition to the deck pedestal system.

1. A minimum of one additional pedestal support must be installed for every 500 lbs. (or portion thereof) of static loading. These additional support pedestals must be installed directly under the decking and evenly spaced immediately below the feature locations. One additional pedestal must be placed under corner of any rectangular feature. In addition we would recommend an additional pedestal be placed in the center for any 2cm porcelain deck tile

E. All decks shall be designed to not exceed the design capacity of the pedestal.

F. The substrate immediately below the pedestals shall provide positive drainage.

G. In the case of decks over roofing substrates, roof systems must meet local building code and be in accordance with the NRCA recommended good construction practices. Only roofing manufacturer approved systems shall be used.

H. Decks over roofing and waterproofing:

1. Elmich Pedestal Installation: Elmich pedestals must be installed on surfaces with a minimum 40 psi bearing capacity

2. Installation: Elmich pedestals must be supported by a surface that provides a minimum 30 psi bearing capacity.

Eco Arbor Designs Deck Tile / Pedestal Sheet

EAD Deck Tile Spec Sheet A.General Deck Pedestals and Wood Tiles Information

1.6 Warranty EAD ECO DECK Tiles and Elmich Pedestals

A. TAt project closeout and upon request, EAD can provide to the Owner or Owners Representative, an executed copy of the manufacturer's standard document outlining the terms, conditions and limitations of their limited warranty against manufacturing defect for a period of three (5) years.

B. It is the responsibility of the Contractor installing the product listed in this section to coordinate warranty requirements with any related sections or adjacent Work. Notify the Architect immediately of any potential lapses or limitations in warranty coverage.

C. . For use with pedestrian traffic only – Never use Elmich pedestals to support decks that have wheeled, motorized or equipment traffic.

D. Decks should be restrained on all sides and not have lateral movement in excess of 1/8”.

E. Warrant that Work of this Section will remain free from defects in labor and materials used in accordance with Division 01 General Conditions of this project for five years from the date of Substantial Completion.

2.1 ECO ARBOR DESIGNS STRUCTURAL ECO DECK TILE Porcelain Pavers

Manufacturer /Importer: Eco Arbor Designs Inc 2525 San Clemente Ave Suite A, Vista, CA 92084 ph: 888 359 4435, fax: 831 515 5054, email info@ecoarbordesigns.com web www.ecoarbordesigns.com
Applications/Scope

A. Furnish and install a complete adjustable deck support system with a maximum cavity height of up to:

1. Versajack Pedestals maximum cavity height 22 inches (610 mm).
2. Versajack Pedestals with Elmich extender system for excess height installations in the range of 1.5-40 inches.
3. Deck supports are not designed for supporting decks that carry vehicular traffic or equipment including but not limited to snow removal equipment, ATV's, forklifts, or any motorized vehicles.

B. Consult EAD and the Project Engineer regarding the following:

1. When spacer tab condition or design requires spacing between decking tiles or concrete pavers other than the standard spacing required by the manufacturer. Spacers are available in 4mm and 6mm gauge.
2. When considering use for other than a raised decks (e.g. interior floors, stairs, etc.).
3. When the required pedestal height exceeds the safe limits as determined by the Manufacturer.
4. When pedestal load capacity exceeds the maximum listed.
5. When anticipating installation of any items with excess weight on top of the deck.

C. Installation of EAD ECO DECK Tiles (IE: Ipe deck tiles, 2cm porcelain and stone deck tiles)

3.1 Examination

- A.** Verify that all surfaces, membrane(s), protection board, insulation, drains, are free from dirt, oil, grease or any deleterious substances and debris which may prevent installation, drainage, and stability of the paving slab installation.
- B.** Verify that roof deck has at least 1-1/2 percent but no more than 2 percent slope to drains.
- C.** Do not begin paving work until such conditions have been corrected and are ready to receive leveling materials.

Eco Arbor Designs Deck Tile / Pedestal Sheet

EAD Deck Tile Spec Sheet A. General Deck Pedestals and Wood Tiles Information

3.2 Preparation

- A.** Establish accurate lines, levels and pattern.
- B.** The substrate surface that will receive the deck supports must be well compacted (on grade) and structurally capable of carrying the dead and live loads anticipated.
- C.** The substrate must be clean and free of projections and debris that could impair the performance of the pedestals or the total deck system.
- D.** Decks over roofing and waterproofing
- E.** Decks on Grade: verify that installation conforms to section 1.7I of this specification.

F. Installation requirements vary for each individual project site. Deck materials used, pattern, grid layout, starting point, and finished elevation should be shown on plan view shop drawings which have been prepared and approved by the designer, installing contractor and/or owner.

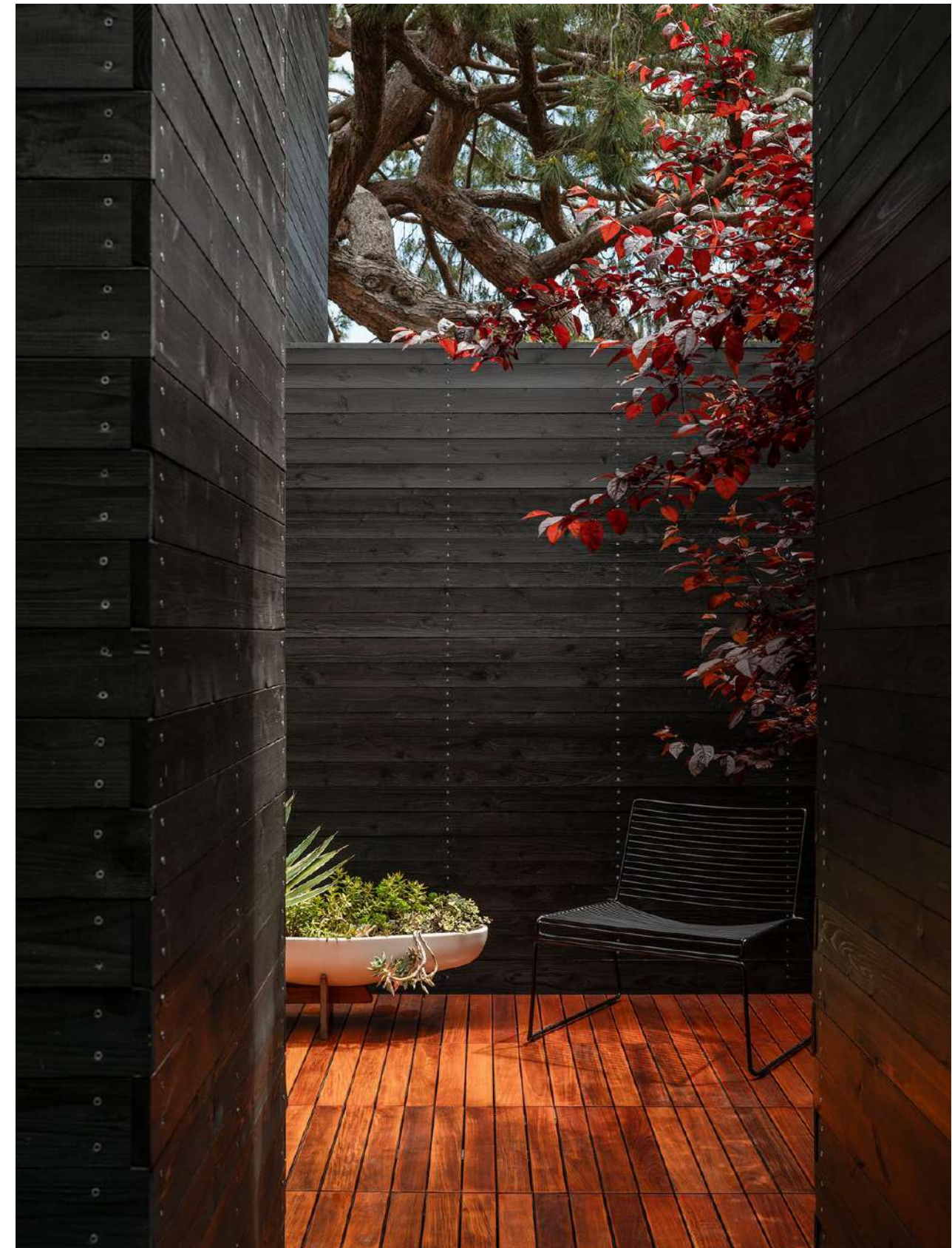



G. Once a starting point and the finished elevation of the deck surface have been determined, the support system elevation (finished elevation minus deck material thickness) is established and marked around the perimeter using a transit “torpedo” water level or laser leveling device.

3.3 Installation of pedestals and surface deck tiles, EAD ECO DECK, 2cm Porcelain or Stonedeck

A. Install in accordance with manufacturer’s instructions.

B. If required, place a 1 or 2mm rubber shim where each pedestal is to be laid out to cushion the base against the waterproof surface.

C. Next, a deck support must be placed where each measured grid line meets the perimeter. Remove two (2) spacer tabs in line with one another on top of each deck support placed around the perimeter. Remove all four (4) spacer tabs at corners. Any combination of this can be achieved to space the tiles where less than 4 spacer tabs are needed.

D. Adjust each deck support to the desired height required, fine tuning can be done once the surface material of EAD ECO DECK wood tiles , 2CM porcelain deck tiles or Stonedeck tiles are laid on top.

E. On larger decks, it is recommended that pedestals be pre-sorted and pre-set to the proper elevation and placed in position prior to the installation of pavers or tiles. This is called the layout.

F. As the deck supports located along the grid lines are loaded with pavers or tiles, fine vertical adjustment can be made by rotating the base or bottom of the deck support. Clockwise rotation of the pedestal base will raise the bearing surface and the deck. Counter-clockwise rotation will lower the top bearing surface.

G. Elmich pedestals have built in height limit indicator. When pedestal is fully extended, height limit indicator can be felt with the hand, indicating the maximum height of the pedestal. Do not extend pedestal beyond the height limit indicators. Do not exceed maximum height listed on pedestal; use the next size pedestal in the series. Never over extend any pedestal

H. Slight irregularities in decking panel thickness can be compensated for by using one to two mm rubber shim segments. Place on top of the pedestal, under the corner(s) of the decking tile or paver. Use no more than two (2) shims on top of the pedestal and always adhere 1/4 wedges with construction adhesive.

I. Spirapave and Versajack Series Slope Compensation:

1. The ESP and Versajack Series has integrated leveler disks that compensate for up to . inch per foot slope. Additional slope compensation can be added by placing a bottom slope correct in addition to the top slope corrector. Standard rubber shims can be used to level the bottom of the pedestal.



Eco Arbor Designs Deck Tile / Pedestal Sheet

EAD Deck Tile Spec Sheet A. General Deck Pedestals and Wood Tiles Information

1. Shims may be used in multiples, whole or segmented, and placed under the base to level the deck support.
2. Under a pedestal: All shims under a pedestal must be adhered to each other or the pedestal (NOT to the roofing membrane) with construction adhesive. Shim no more than 1 and 2mm beneath each pedestal. The use of Jiffy Seal double sided adhesive rubber flashing paper in 1mm thickness can be very useful for a floating base layer between pedestal and roofing membrane or similar surface
3. On top of a pedestal: Use no more than 4 rubber shims.

3.4 Deck Support Placement And Final Adjustment

- A. Deck supports and the deck surface panels must be placed as the manufacturer directs in these written instructions. Use of labor saving devices, such as paver lifters and pedestal turning keys is recommended
- B. Pedestals are designed to be rotated for final slight adjustment when pedestals are fully loaded. Deck supports should be leveled in each succeeding row as the installation proceeds. Final height adjustment or maintenance is easily made by simply rotating the base in a clockwise or counter-clockwise direction to raise or lower the deck surface material.
- C. Additional sections of shims may be used and should be available for regular maintenance. Shims may be used in multiples or placed under the base or on top the pedestal to level the deck support.
- D. On top of pedestal: Use construction adhesive to use adhesive for sections of shims. Construction adhesive is not required when using whole shims on top of a pedestal.
- E. Beneath a pedestal: Use a small amount of construction adhesive for adhesion of sections of shims and/or whole shims to each other or to the pedestal. Unless specified to do so, DO NOT use construction adhesive for pedestal or shims to insulation, roofing or waterproofing membrane.

3.5 Any area of a deck that is not restrained by a parapet or foundation wall must be 'boxed-in' and contained. The deck panels will move if all sides are not adequately restrained. Perimeter containment located at the outside of the deck must be installed to provide restraint. No movement should be allowed at the perimeter of the deck system greater than 1/8"

3.6 Field Quality Control

- A. Inspect often during installation to assure that grid spacer lines are being maintained in a straight and consistent pattern and that deck panels or pavers are level and not rocking.
- B. Confirm that deck pedestal height does not exceed the specified height for the Versajack Series:
 - A. 40 inches maximum pedestal height.
 - B. Unless otherwise specified in writing to allow for expansion, inspect to assure that all paver spacing between tiles and at perimeter containment does not exceed a 1/8". Particular attention should be made to assure that all pedestrian entry or access points to the deck are level and that the deck surface tiles are not randomly raised or uneven creating a hazard.



Eco Arbor Designs Deck Tile / Pedestal Sheet

General Deck Pedestals and Wood Tiles Information

3.8 Immediately Following Installation

A. The Owner, or the Owner's Agent, shall carefully inspect the deck system to be positive that:

1. There are no shakes or wobbling of tiles, that each tile is supported properly.
2. There is no more than 1/16th to 1/8th " spacing between any deck panels and at all sides of the deck perimeter.
3. There is no 'rocking' of deck panels as foot traffic is applied to the surface decking.
4. All required spacer tabs are in place and visible. All required spacer tabs are in place and visible.

3.9 Routine Maintenance And Care

A. Installer and/or Architect has a duty to instruct the deck owner about performing routine maintenance of the deck. Check for rocking pavers and adjust or shim immediately. Substrates can settle and pedestals may have to be readjusted. Failure to do so can cause a tripping hazard. Periodically check spacer tabs and immediately replace broken tabs to limit deck movement. Make sure the edge restraint stays intact and structurally sound.



W Hotel San Diego



Del Mar, CA Balcony





ECO ARBOR DESIGNS

Innovators of modular outdoor flooring. We have been manufacturing, importing and installing some of the finest raised floor systems in the world since 2005

Corp office:

Eco Arbor Designs
2525 San Clemente Ave suite A,
Vista CA, 92084

Toll Free

888 335 8453

Direct Northern California

831 359 4435

Direct Southern California

858 914 2423

Fax

831 515 5054

visit us online at www.ecoarbordesigns.com

email us at info@ecoarbordesigns.com

Warehouse and distribution centers

ECO arbor designs west coast

ELEETS 3pl Logistics

2430 S Grand Ave,
Santa Ana, CA 92705



WARRANTY 5 Year Limited WARRANTY for EcoDeck IPE PAVERS

Eco Arbor Designs warrants Eco Deck IPE PAVERS to be free of defects in material and workmanship under normal use for a period of 5 years from the time of purchase. The product is warranted against defects in material and workmanship. Warranty is subject to normal household, commercial or patio usage, from the date of purchase. Transportation to and from the distributor is the sole responsibility of the customer to determine a warranty claim. Special attention has been given to your new wood product to ensure lasting satisfaction and durability. Eco Decking Tiles are a natural product with natural variation. It is recommended to apply a coat of penetrating hardwood sealer after installation and re applying as needed to maintain color and UV protection if deep wood color and grain is desired. Not coating the wood will allow the wood to patina to a silver grey and will not void the warranty.

NOTES: The Term "defect" as it is used in this warranty is defined as a flaw or deficiency that may affect the use for which the product is intended. This warranty applies only under standard household and commercial conditions for use, and does not cover defects caused as a result of neglect, deliberate damage, abuse, personal alterations, accidents, and maintenance that do not comply with the instructions which form part of this warranty. Only the original owner /purchaser hold the right to a valid warranty. Transportation of product to and from the retailer is the responsibility of the purchaser.

EXCLUSIONS:

Eco Arbor Designs or the Eco Decking Tiles retailer will not be liable in the event of:

- A. **Improper Installation:** Good performance of Eco Decking Tiles is dependent upon proper installation and site conditions. Well drained level areas should accept the tiles. Trying to install the tiles on irregular surfaces can cause inconsistencies in the connection system between each tile.
- B. **Improper Maintenance:** If long lasting color is desired an annual coat of penetrating sealer is required, otherwise wood will naturally patina to a distinguished light silver color. Allowing the patina will not shorten the lifespan of the wood.
- C. **Normal Environmental Conditions:** Our products are warranted to perform in what we consider to be normal applications for exterior decking. Not included in extreme environmental conditions
- D. **Misuse:** We cannot be expected to and will not assume responsibility for damage caused by misuse, abuse or accident. No warranty is provided for any damage due to inadequate care or other factors such as stains or chemicals, worn or narrow heeled shoes (heels with 6MM of diameter or less), Furniture or heavy equipment being dragged across the surface, impact scratches, or scarring caused by pets, or pointed objects.
- E. **Alterations and Repairs:** Alterations to ECO DECK IPE pavers product will void any and all warranty. This includes cut or altered tiles that are not in accordance with our recommended method of shortening or modifying the pavers, such as improper tools used or tiles left with improper bracing underneath.
- F. **Reinstallation:** In the event that Eco Arbor Designs elects to replace warrantied tiles. Eco Arbor or said distributor shall in no manner be obligated to provide or incur costs of removing or re-installing the defective tiles or resurfacing or refinishing the replaced or surrounding flooring. Eco Arbor has no obligation to replace or repair shall extend to any sub floor materials, including adhesives, supplies or other items consumed in the course of removal, installation or refinishing.



ECO ARBOR DESIGNS