



ECO ARBOR DESIGNS

# 2cm Porcelain Pavers

# EcoDeck™ Structural Porcelain Tiles

BY ECO ARBOR DESIGNS

Our “Modular Porcelain Paver flooring solution that is attractive, durable, impact resistant and are quick and easy to install and remove if needed.

Suitable for both residential and commercial applications, our porcelain paver decks are ideal for adding raised roof decks or resurfacing existing concrete patio and balcony areas. Porcelain Pavers are modular and removable creating an advantage over thin set tile or framed decks

Structural Porcelain Pavers are easy to clean, do not absorb moisture or stains and can hold an incredible amount of weight making them the perfect surface for even the heaviest of traffic walk decks.

With over 30 colors in stock we have the perfect look and feel for your project.

Porcelain pavers are able to be set on pedestals for raised floors or simply thin set to your existing concrete deck.



## EcoDeck Porcelain Deck Tiles | Uses

- Building elegant and refined creative rooftop or ground level patio decking environments
- Urban patios, terraces and rooftop decks, balconies.
- Commercial or residential flat rooftop terraces and plazas
- Decks on green roofs or any surface where you don't want a built up deck with limited access. A modular tile system creates easy access to the roof surface as well as protects the waterproofing from impact and exposure.
- Residential decks over cracked concrete patios or uneven surfaces, simply cover and level the pavers over your existing cracked or ugly surface.
- Decking and landscaped areas on street and curb sides
- Commercial Decks, residential decks and retrofitted decks

## Advantages of EcoDeck Structural Porcelain Tiles for raised floors

- Capable of supporting loads up to 2200 lbs,
- Durable and hard wearing for high traffic commercial areas, no fading or maintenance
- Fire Proof can be used in localities with strict fire codes
- Slip resistant, stain resistant, and frost resistant suitable for all climates and meets all ASTM requirements. Dense and non porous resistant to grease oil stains, algae and mold growth
- Half the weight of any similar sized concrete paver with many more types of finishes and colors.
- Wind Uplift and structural support for elevated decks are addressed with our Porcelain Paver Support tray
- Decking and landscaped areas on streets and curb sides
- Commercial decks, residential decks and retrofitted decks

ECODECK SIMULATED HARDWOOD Porcelain Pavers available in a range of colors



Oak (light brown)



Pepper (grayish brown)

# EcoDeck™ Porcelain Deck Tiles | Overview

A highly versatile flooring product which is lightweight and easy to clean. Porcelain can be power-washed repeatedly without issue as well as cleaned with any cleaning products.

Gapping on edges typically is 1/8th inch allowing water to percolate through but not allow any large leaf debris. This creates a lightweight yet super durable flooring option for any outdoor space. Spacing can be as little as 1/16th between pavers if a more seamless look is desired.

Porcelain 2'x 2' actual size is 23.6" x 23.6"

## Advantages of EcoDeck™ Structural Porcelain Tiles for raised floors

- Capable of supporting loads up to 2200 lbs
- Durable and hard wearing for high traffic commercial areas, no fading or maintenance
- Fire Proof can be used in localities with strict fire codes
- Slip resistant, stain resistant, and frost resistant suitable for all climates and meets all ASTM requirements Dense and non porous resistant to grease oil stains, algae and mold growth
- Half the weight of any similar concrete paver
- Wind Uplift is addressed with our Porcelain Paver Support tray
- Decking and landscaped areas on streets and curbsides
- Commercial decks, residential decks and retrofitted decks

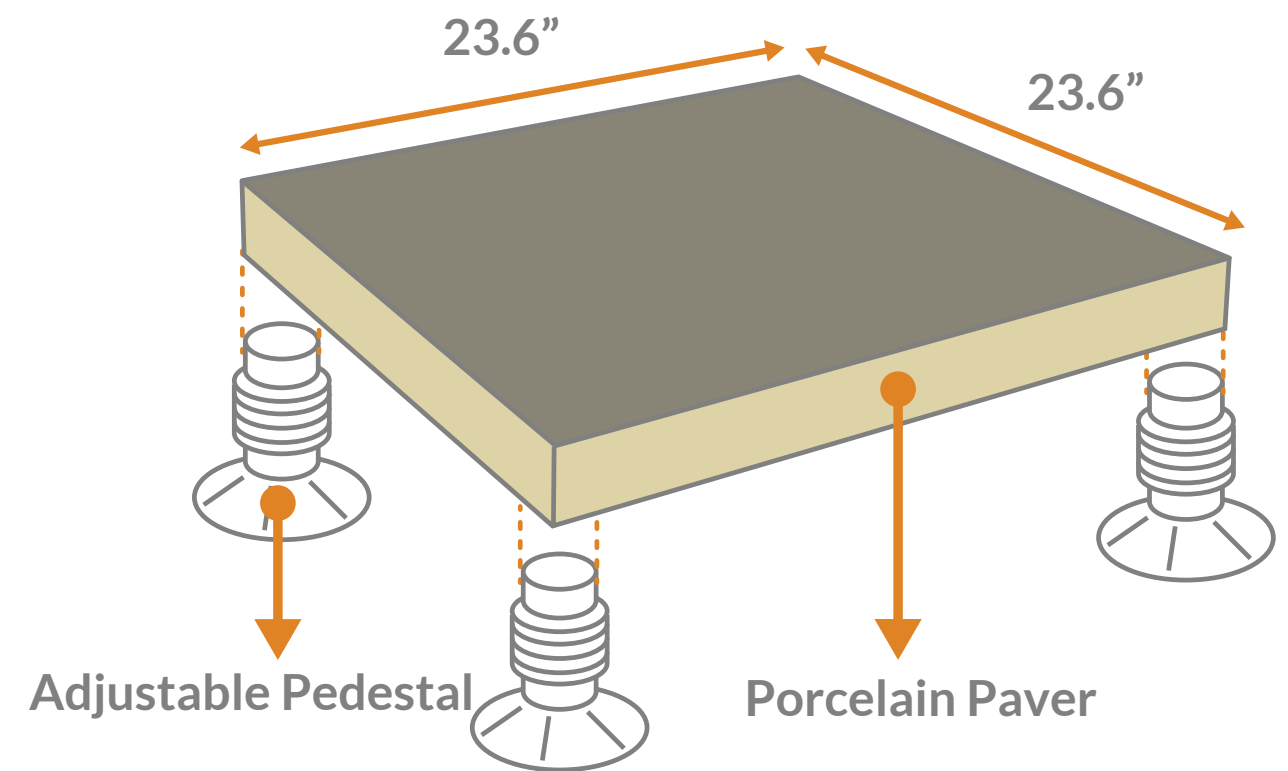

Mortar Bed over concrete



Loose Sand/Gravel set

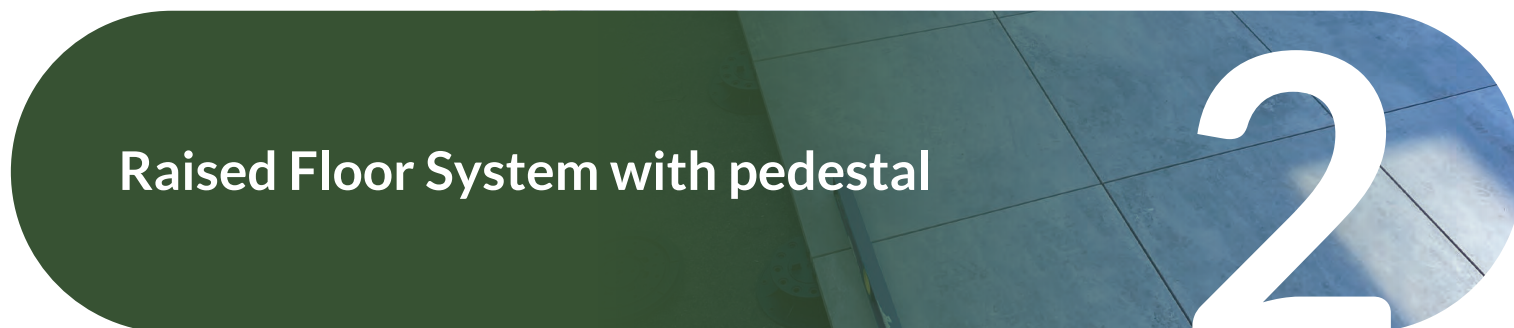

Raised Floor System with pedestal

## EcoDeck™ Porcelain Deck Tiles | Overview



# LIMESTONE



Natural Ivory V2  
24"x24"

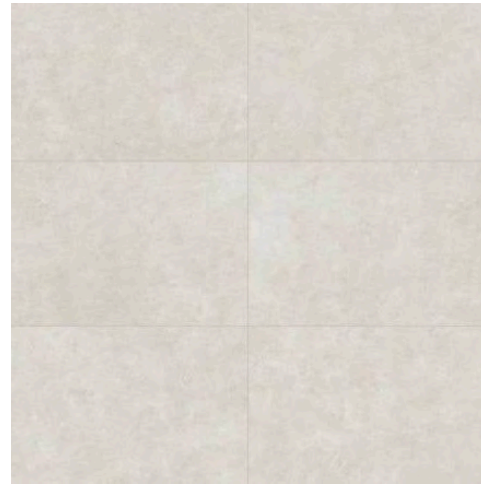

International White V2  
24"x24"



Moon White V2  
24"x24"



Indiana Buff Select V2  
24"x24", 12"x48", 24"x48"



Miami White V2  
24"x24"



Limestone V2  
24"x24", 24"x36", 24"x48"



Sky V2  
24"x24"

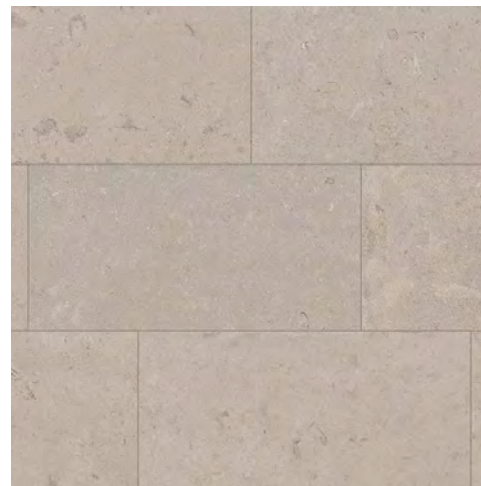

Antique Cream V2  
24"x24", 24"x36", 24"x48"



Desert V2  
24"x24"



Indiana Variegated V3  
24"x24"

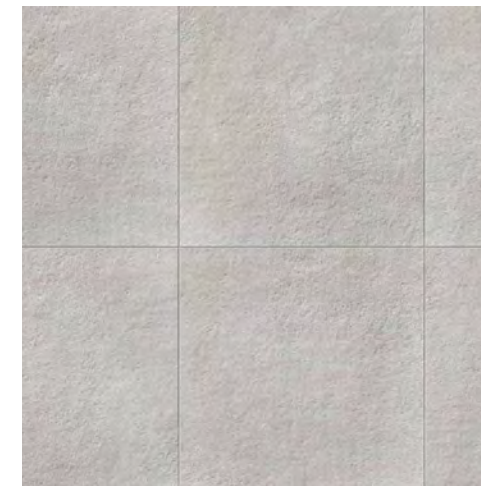

Indiana Grey Select  
24"x24", 12"x48", 24"x48"

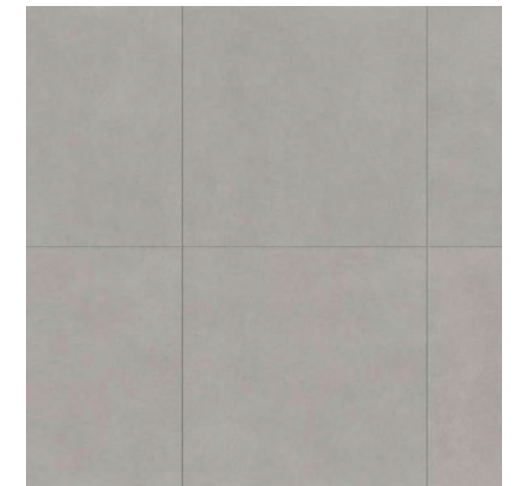

Cosmopolitan Ash V2  
24"x24", 12"x48", 24"x48"



Absolute V2  
24"x24"

## COLOR VARIATION GUIDE

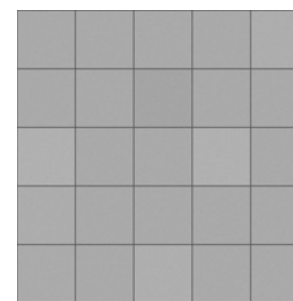

V1 - UNIFORM APPEARANCE

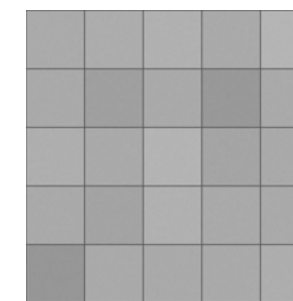

V2 - SLIGHT VARIATION

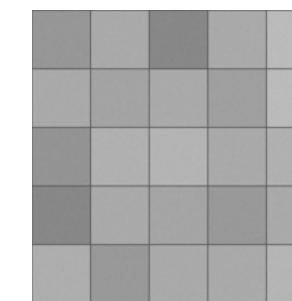

V3 - MODERATE VARIATION

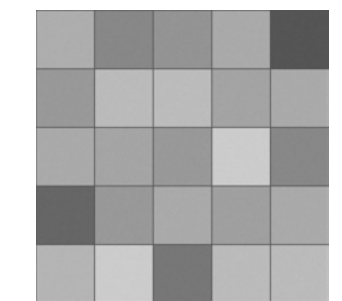

V4 - SUBSTANTIAL VARIATION

# BLUESTONE

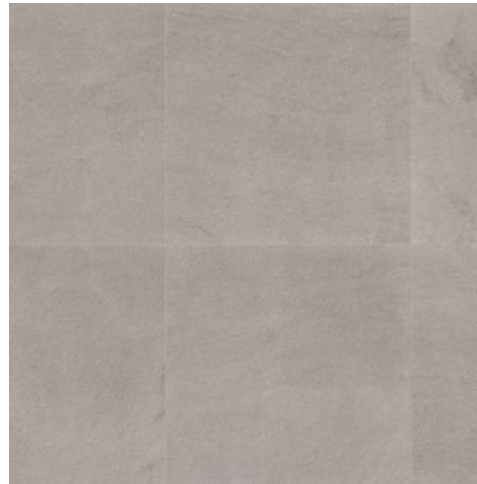

Thermal Bluestone Blue Select V2

24"x24", 24"x36"

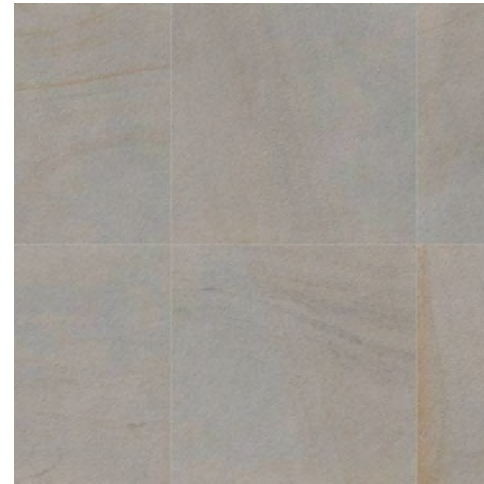

Thermal Bluestone Full Color V3

24"x24", 24"x36"



Bluestone Full Color V3

24"x24", 12"x48", 24"x48"



Pennsylvania Blue V3

24"x24"



Tumbled Bluestone Cobblestone Cube V2

24"x24"



Tumbled Bluestone Cobblestone Multisize V2

24"x24"



Blue Select Bluestone Cobblestone Multisize V2

24"x24"

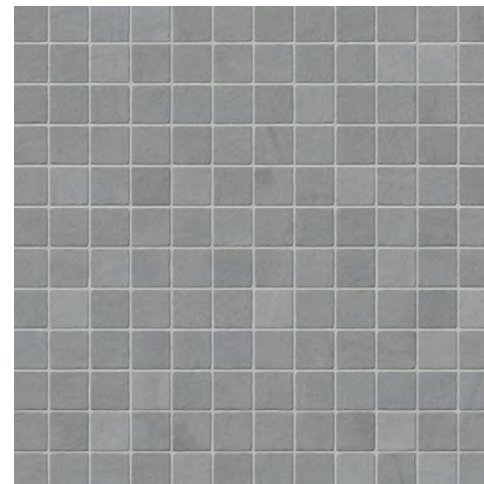

Blue Select Bluestone Cobblestone Cube V2

24"x24"



Bluestone Blue Select V2

24"x24", 12"x48", 24"x48"

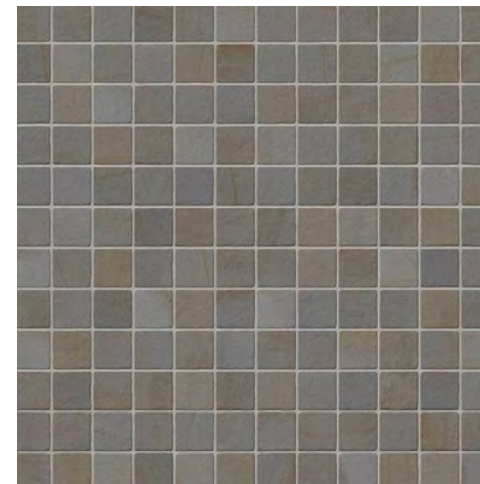

Full Color Bluestone Cobblestone Cube V3

24"x24"



Full Color Bluestone Cobblestone Multisize V3

24"x24"

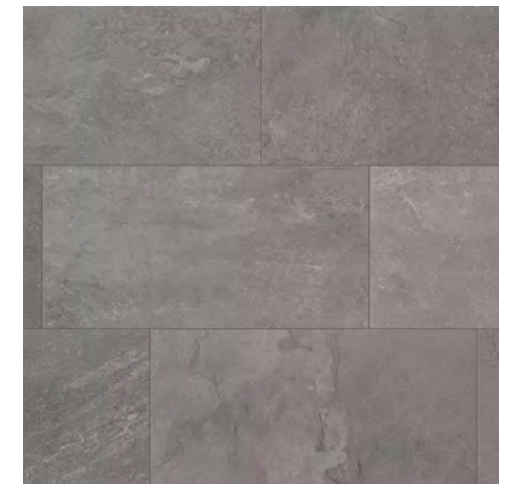

Heirloom Blue V2

24"x24", 24"x36", 24"x48"

# CONCRETE LOOK

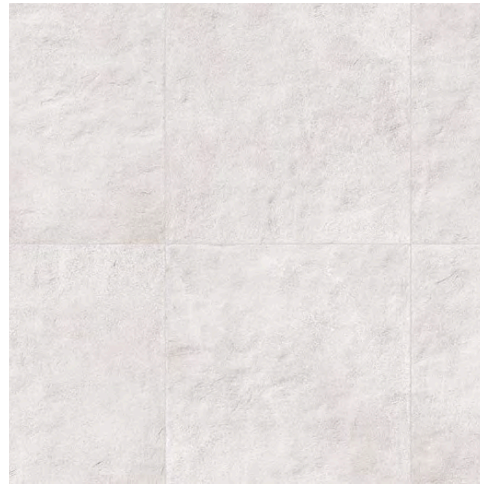

Freedom White V2  
24"x24"



Chalk V2  
24"x24", 12"x48", 24"x48"



Passion Silver V2  
24"x24"



Greige V2  
24"x24", 12"x48", 24"x48"



Ash V2  
24"x24", 12"x48", 24"x48"



Simple Grey V1  
24"x24"

# SLATE LOOK



Pennsylvania Grey V3  
24"x24"



Flagstone Brown V3  
24"x24"



Multicolor Gold V4  
24"x24"

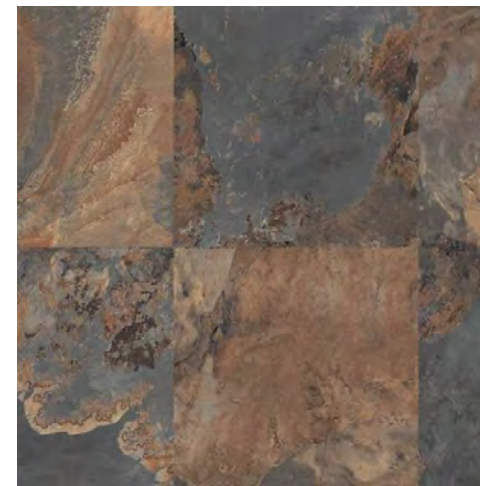

Multicolor Dark V4  
24"x24"

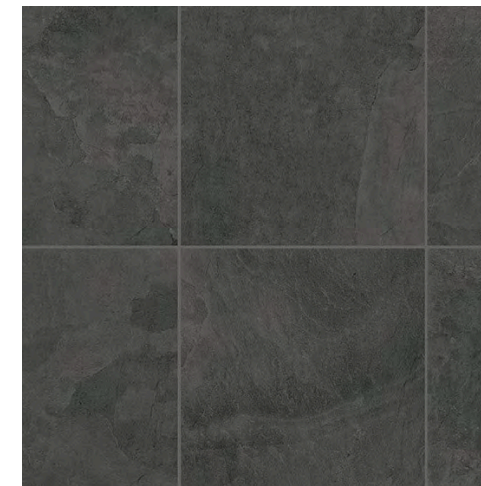

Vintage Slab V2  
24"x24"

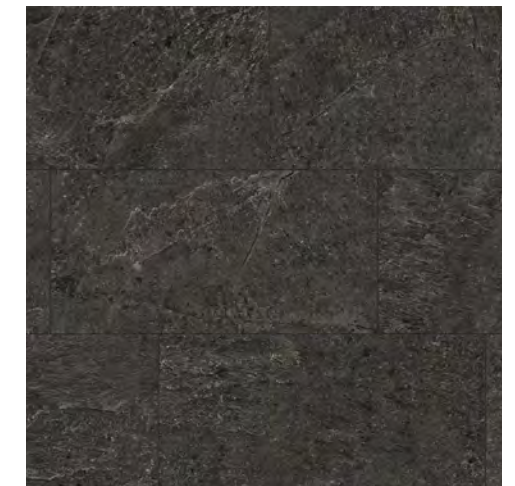

Slate V2  
24"x24", 24"x48"



# MARBLE



Michelangelo Extra White V2

24"x24", 12"x48", 24"x48"



Legacy White V3

24"x24", 24"x36", 24"x48"



Ice V2

24"x24"



Minimalist Greige V2

24"x24"



Gea V2

24"x24"



Modern Grey V2

24"x24"



Wind V2

24"x24"



Titanio V3

24"x24"



Graustein V2

24"x24"

# TERAZZO



Diamond White V2

24"x24"

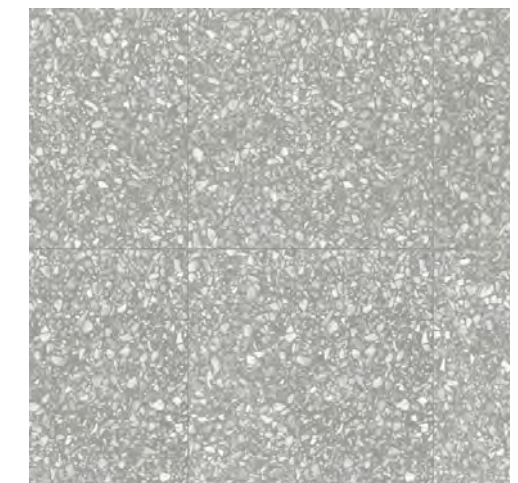

Fashion Grey V2

24"x24"

# QUARTZ



Extra White V3

24"x24", 12"x48", 24"x48"

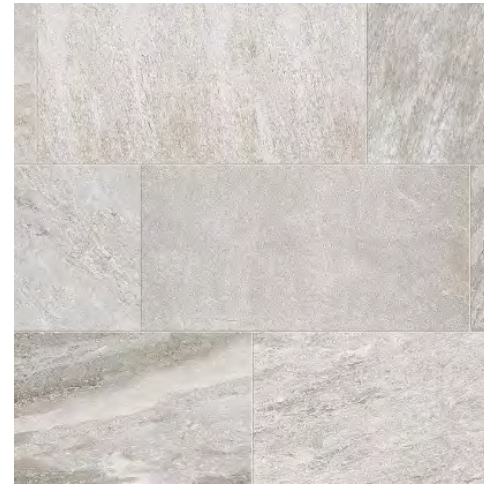

Quartz White V3

24"x24", 12"x48", 24"x48"

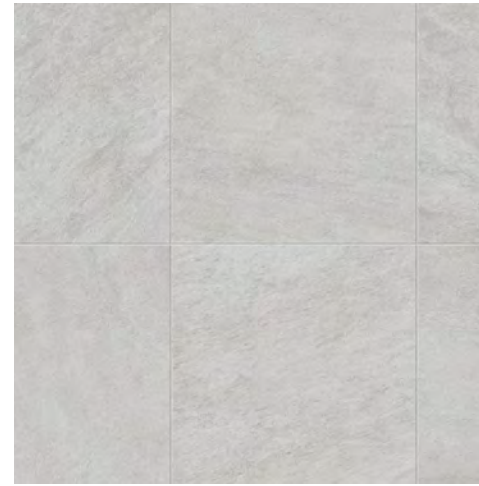

Arctic White V2

24"x24", 12"x48", 24"x48"



African Beige V2

24"x24", 12"x48", 24"x48"



Barge Gold V3

24"x24"

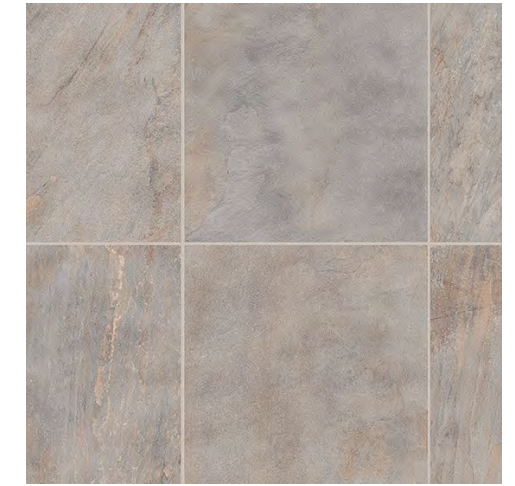

Silver Quartz V3

24"x24"



Star Gey V2

24"x24", 12"x48", 24"x48"

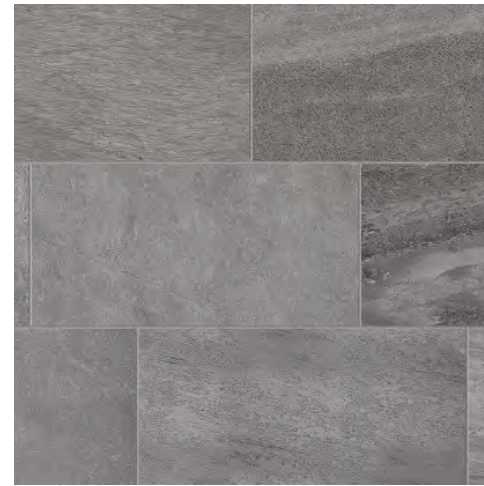

Quartz Grey V3

24"x24", 12"x48", 24"x48"



Manhattan Grey V2

24"x24"



Light Grey V2

24"x24"

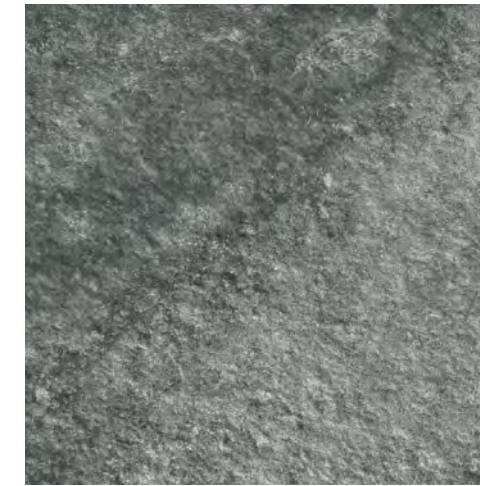

Dark Grey V2

24"x24"



Multicolor V2

24"x24"

# TRAVERTINE



Cross Cut White V2  
24"x24", 12"x48", 24"x48"



Alabaster V2  
24"x24", 24"x48"



Cross Cut Cream V2  
24"x24", 12"x48", 24"x48"



Cross Cut Silver V2  
24"x24", 12"x48", 24"x48"



Pewter V2  
24"x24", 24"x48"



Cross Cut Noce V2  
24"x24"

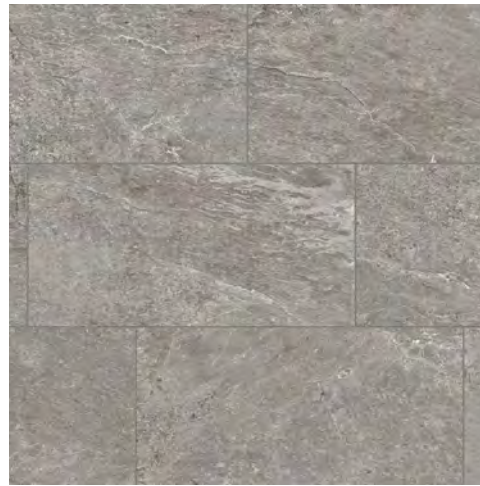

Millstone V2  
24"x24", 24"x48"

# WOOD LOOK



White V3  
12"x48"



Honey V3  
12"x48"



Soul Walnut V3  
12"x48"

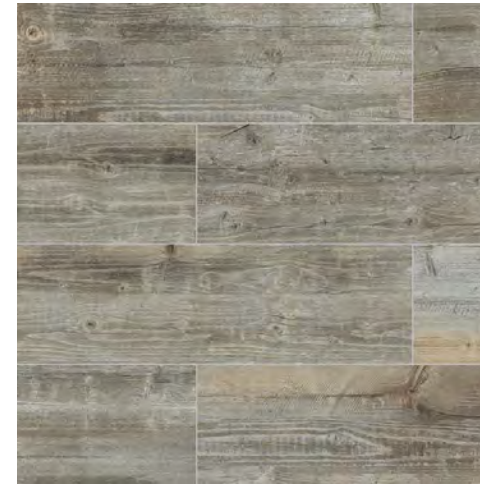

Soul Grey V3  
12"x48"



Pepper V3  
24"x24"



Grey V3  
12"x48"

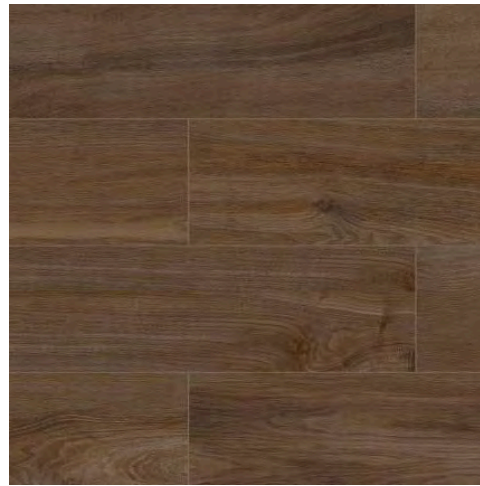

Essence Brown V3  
12"x48"



Walnut V3  
24"x24"

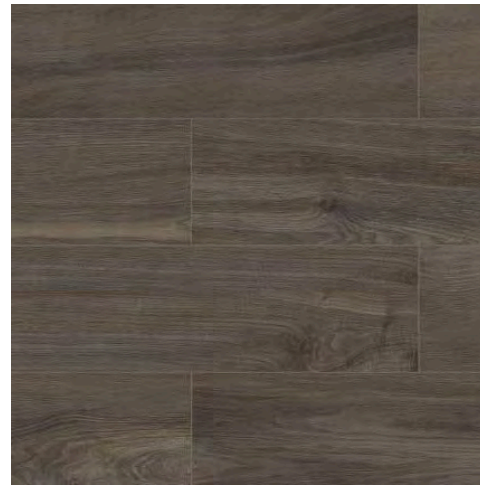

Essence Grey V3  
12"x48"

# SPECIALTY

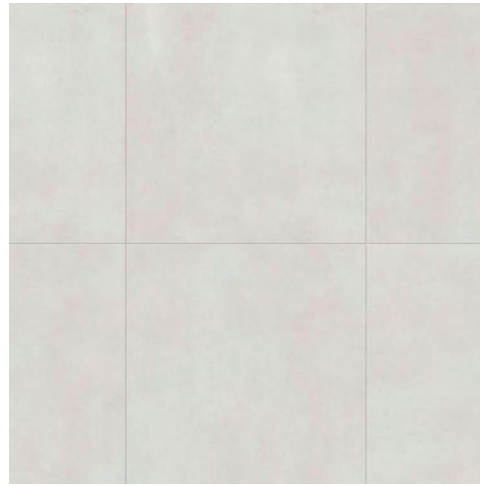

White Ave V2

24"x24", 12"x48", 24"x48"

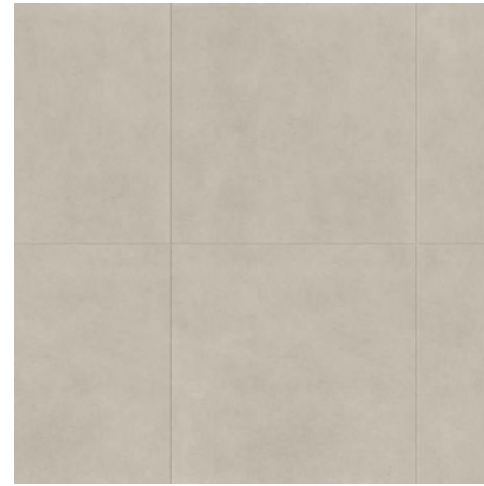

Artistic Beige V2

12"x48"



Fashion Black V2

12"x48", 24"x48"



Cosmos V2

12"x48"



Patchwork White

24"x24"



Patchwork Ash

12"x48"



Patchwork mix

12"x48"

# ADVANTAGES of 2CM and 3CM

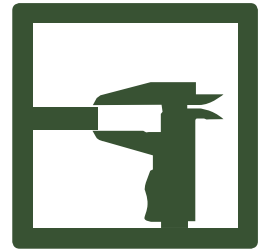

**Monolithic**  
Single-piece



**Sustainable**  
Eco-sustainable



**Fire Proof**



**Frost Freeze Proof**

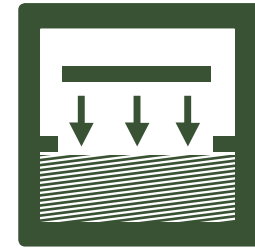

**FAST INSTALLATION**  
Quick and easy to instal



**No water absorbtion**  
Avoiding the risk of breaking and cracks

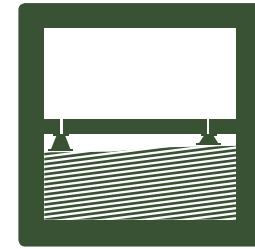

Correcting planarity defects



**RIUTILIZZABILE**  
Reusable  
Réutilisable  
Wiederverwendbar  
Возможность многократного использования



**REMOVABLE AND MODULAR**  
Easy to inspect and removable sub surface

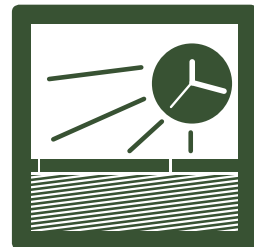

**WEAR RESISTANT**

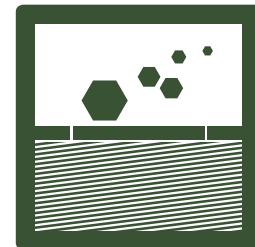

**NO CALCIFICATION OR SALT BUILDUP**



**ANTI SLIP**



2200 lb dead weight breakage point

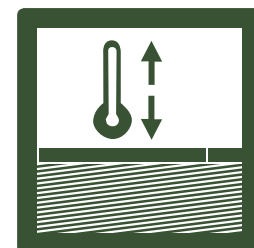

**RESISTANT TO THERMAL SHOCK**

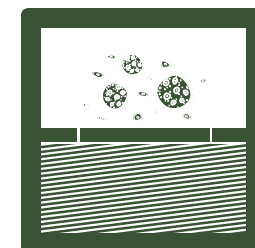

**MOLD AND ALGAE RESISTANT**



**ON GROUND**  
Installation over grass



**PEDESTAL RAISED INSTALLATION**



**INSTALLATION OVER ROAD BASE GRANITE MIX**



**INSTALLTION OVER SAND**  
for beach boardwalks





VIRT







QUARTZ WHITE  
2x2 2cm Paver



URBAN GREY  
2x2 2cm Paver

URBAN GREY  
22CM Paver



Life Oak  
60x60  
Aextra20

### A choice of absolute consistency.

Thanks to the many possible options of Eco Deck Porcelain paver 2cm thickness range, steps, pathways and similar solutions cease to be a problem for planners and become another reason to draw on personal expressive capabilities.

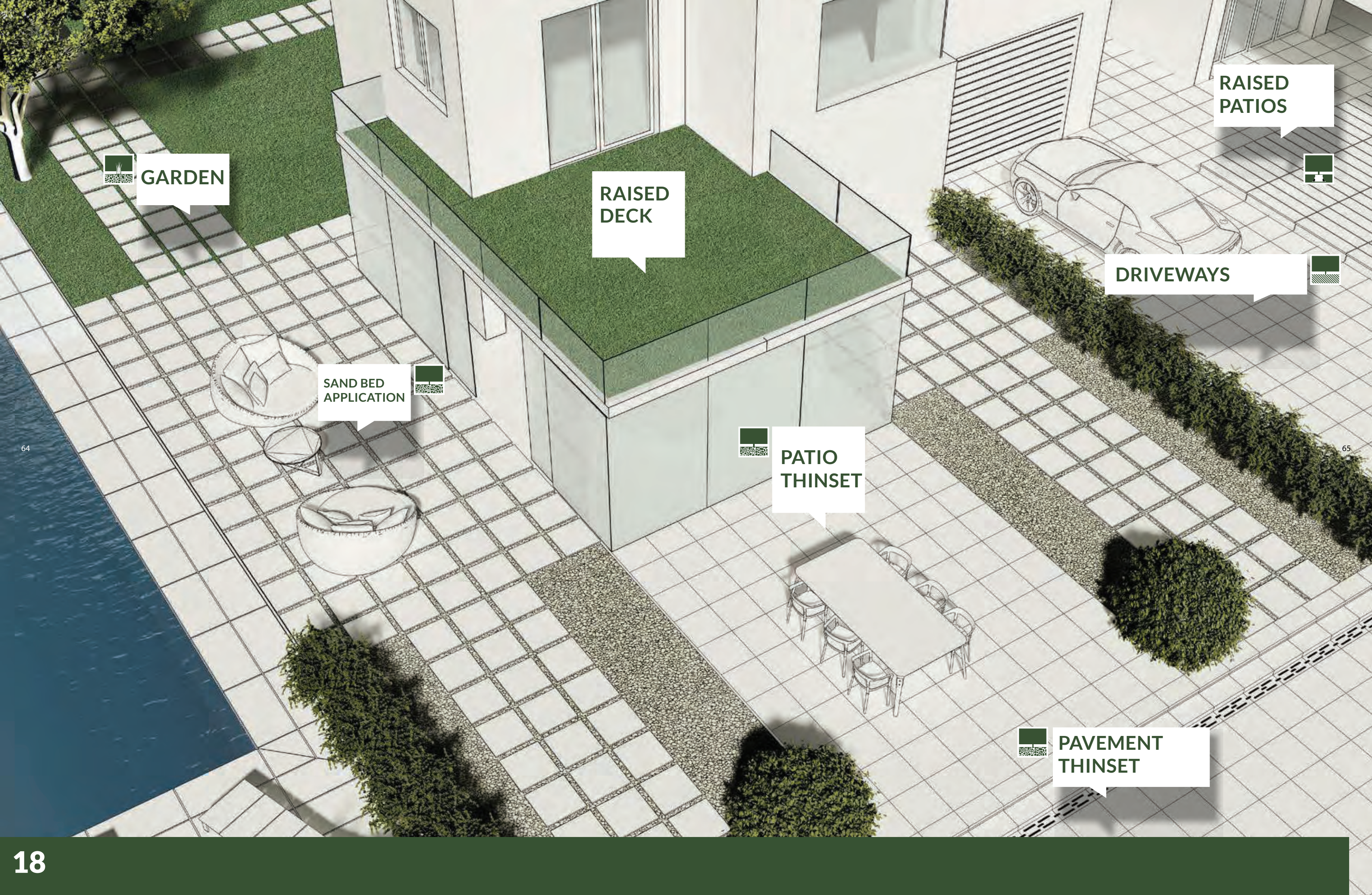

 **GARDEN**

**RAISED DECK**

**RAISED PATIOS**

**DRIVEWAYS**

 **SAND BED APPLICATION**

 **PATIO THINSET**

 **PAVEMENT THINSET**

# 2CM Porcelain pavers installed with a variety of pedestal systems



Adjustable low height pedestals



EAD Adjustable pedestals up to 13" with bottom slope correction



Fixed height stackable rubber pedestals or low height adjustable pedestals

# Types of 2cm Porcelain Paver installations

## GARDEN GARDENS . JARDINS . GÄRTEN .

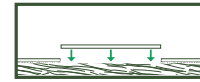

Dry-system spaced installation onto grass .

A

B Decomposed granite base  
Soil . Terrain .

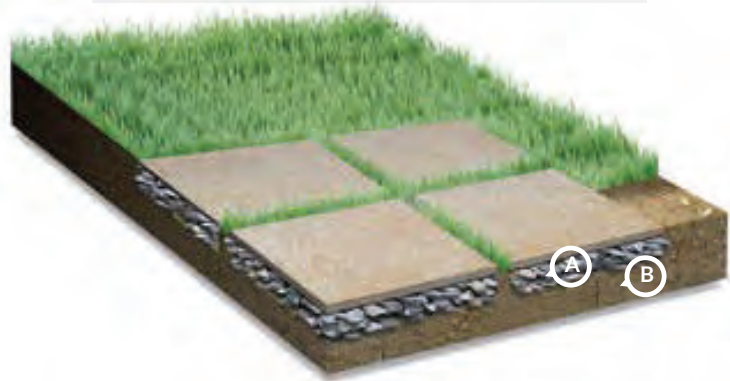

## ON GRADE SAND set

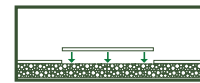

Set into decomposed granite sand set for ground level applications. Road base with 1-2 inch top layer of sand

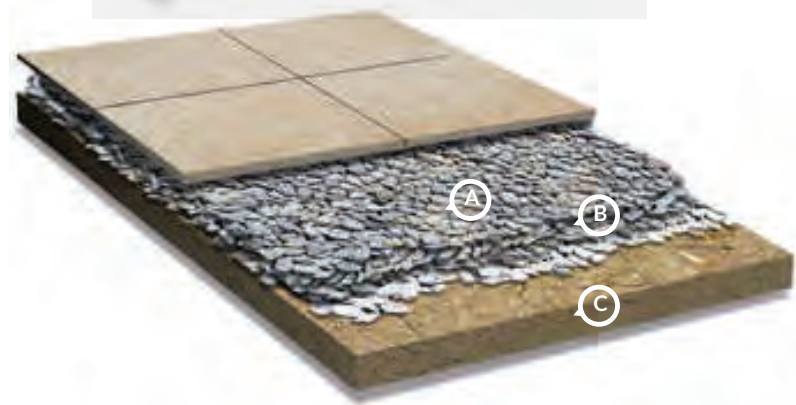

## THINSET APPLICATION OVER CONCRETE



Thin set over concrete for ground level patios, walkways, or driveways

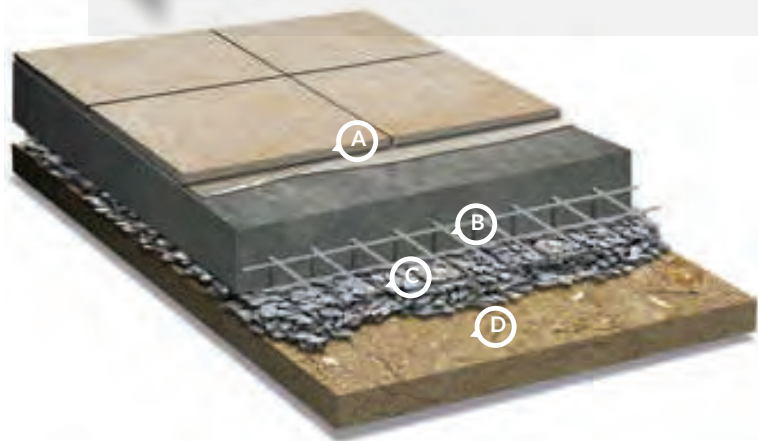

## PEDESTAL RAISED FLOOR

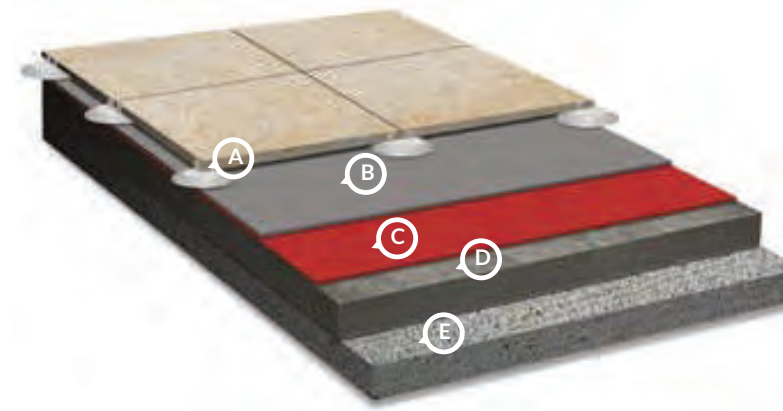

Raised floors for roof decks, patios or over any type of waterproof membrane

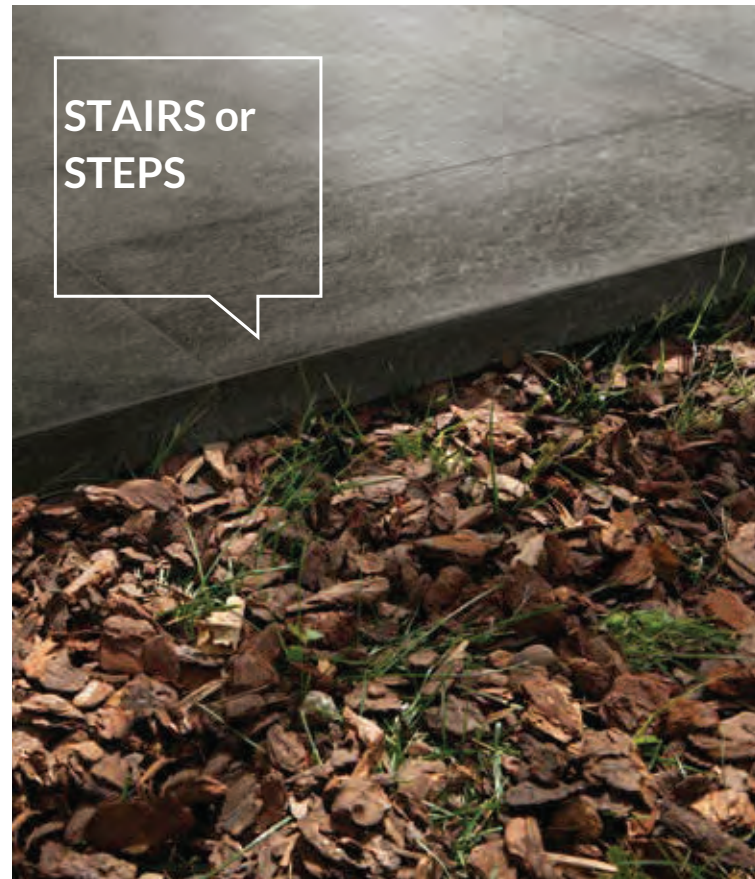
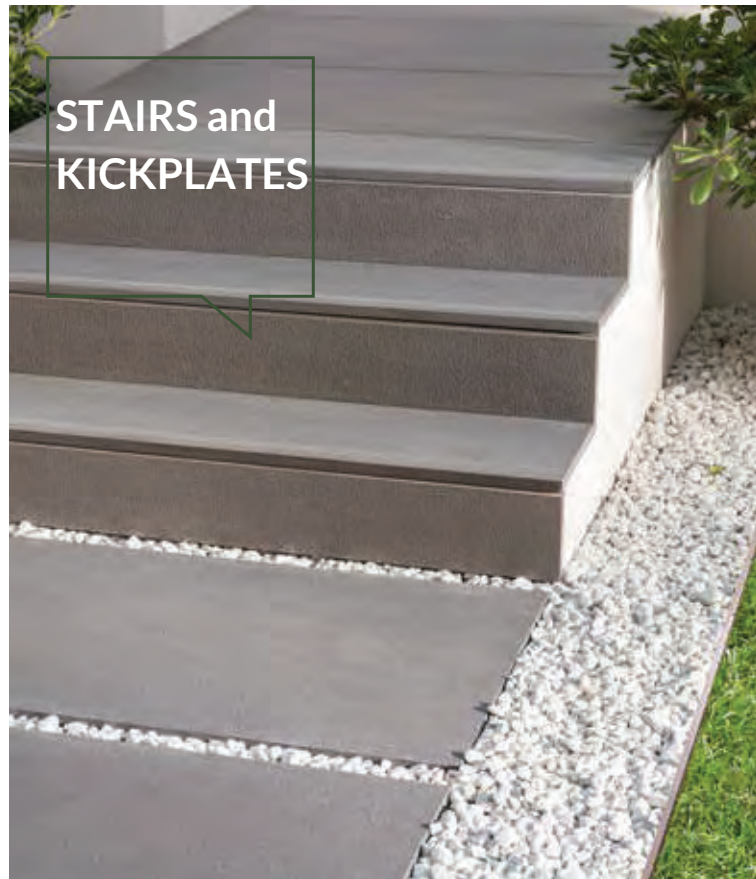
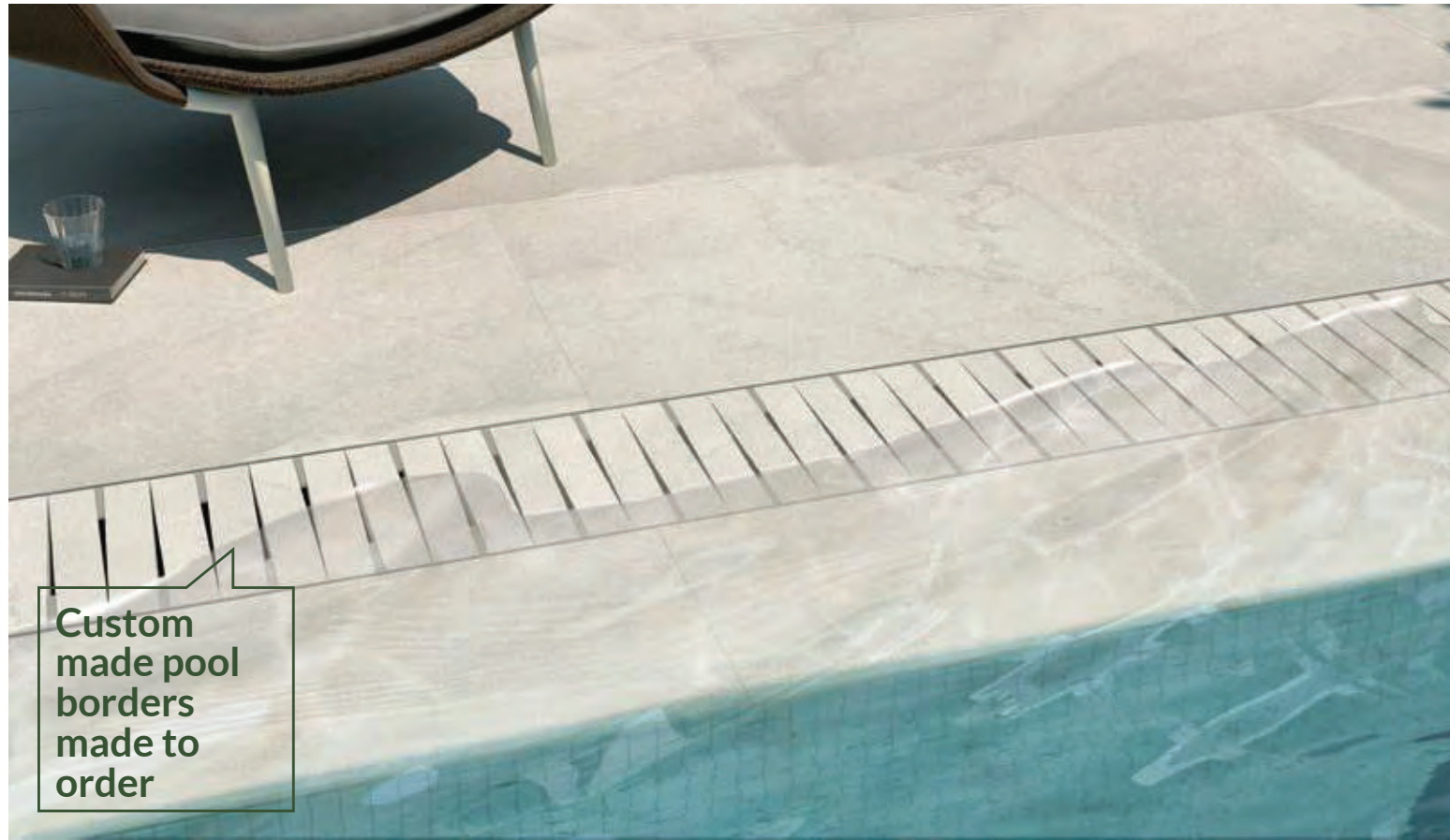

**XSTEP**

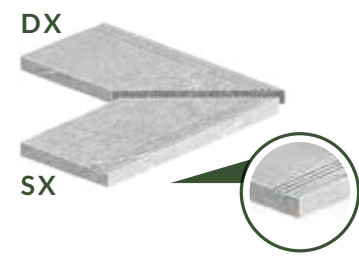
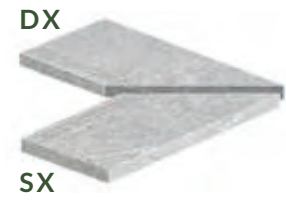
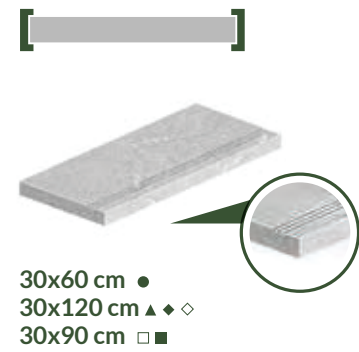

30x120 cm ▲◆◇  
30x90 cm □■

**XGRIP**

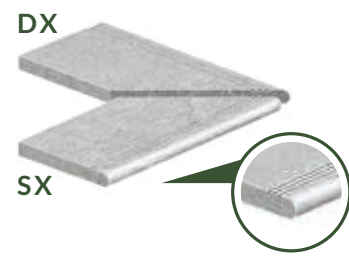
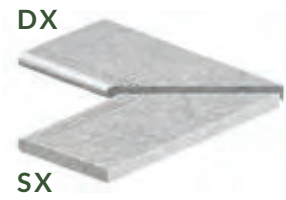
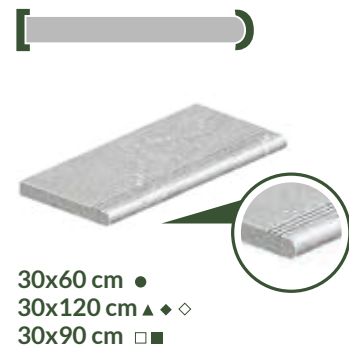

30x120 cm ▲◆◇  
30x90 cm □■

**ROUND**

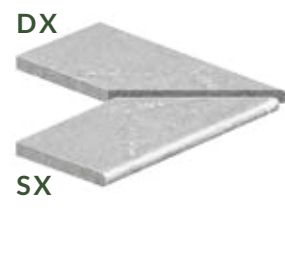
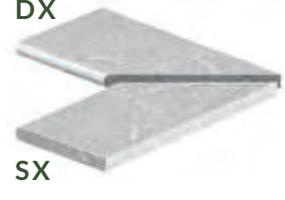
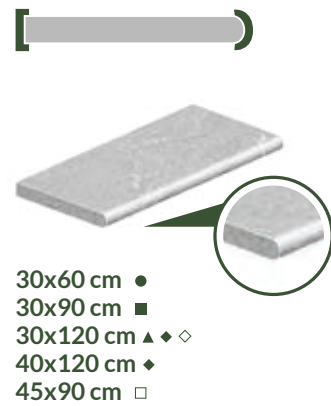

30x120 cm ▲◆◇  
40x120 cm ◆  
45x90 cm □

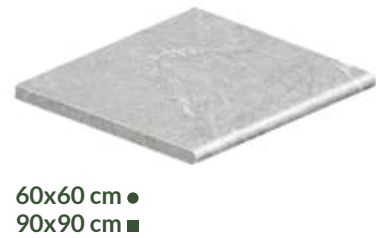

30x60 cm ●  
30x90 cm ■  
30x120 cm ▲◆◇  
40x120 cm ◆  
45x90 cm □



30x60 cm ●  
30x90 cm ■  
30x120 cm ▲◆◇  
40x120 cm ◆  
45x90 cm □

**ALZATA**

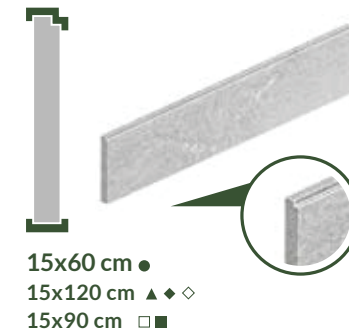

**STAIR**

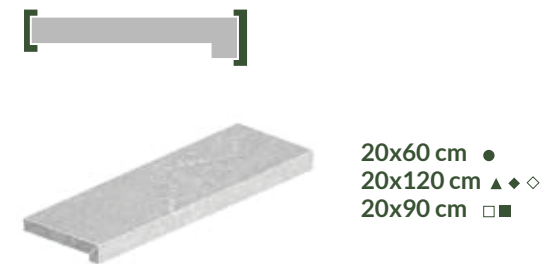

angolo  
Corner - Angle - Ecke - Угол

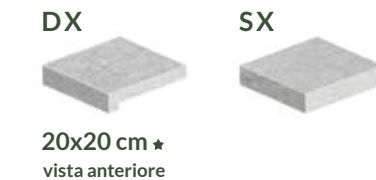
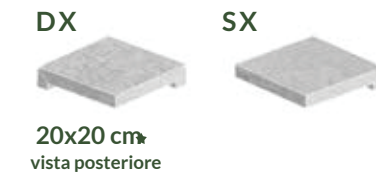

**CURVE**

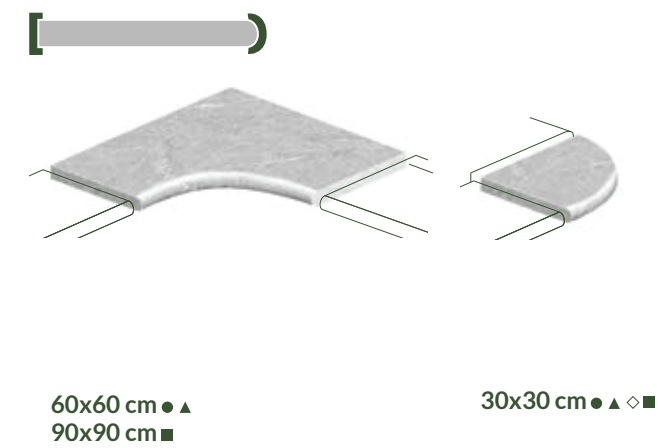

**COMBO**



**ARRONDI**

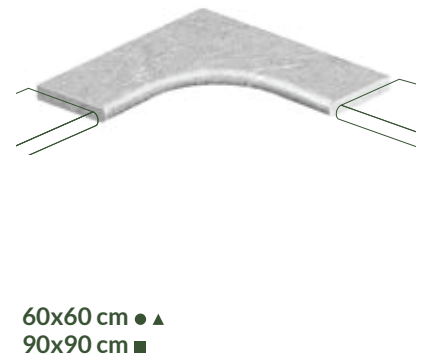

**TOP**



# ECO DECK PORCELAIN PAVER INSTALLATION GUIDLINES

Our porcelain paver deck tiles will install easily and quickly over virtually any surface with the appropriate installation methods.

**Pedestal system.** Lay out the deck on paper and find where the row of cut end pavers will sit. Plan your finished floor heights and roughly adjust and place each pedestal every 2 feet across the field. begin laying pavers and leveling as you set the adjacent paver. Make sure the pedestal top is level enough to not create wobbles. If this is not possible use rubber shims and insert under the paver corner.

For heights above 3-4" we recommend the use of our paver support tray. Our FRP support trays are laid on top of the pedestals to essentially create a new support floor. The pavers then sit over a top of this new floor using our fixed height rubber shims. Since the support floor is already level the pavers do not need to be shimmed to level on top.

Use wall spacers against all parapet walls surrounding the field, this keeps the paver square and in place on the perimeter.

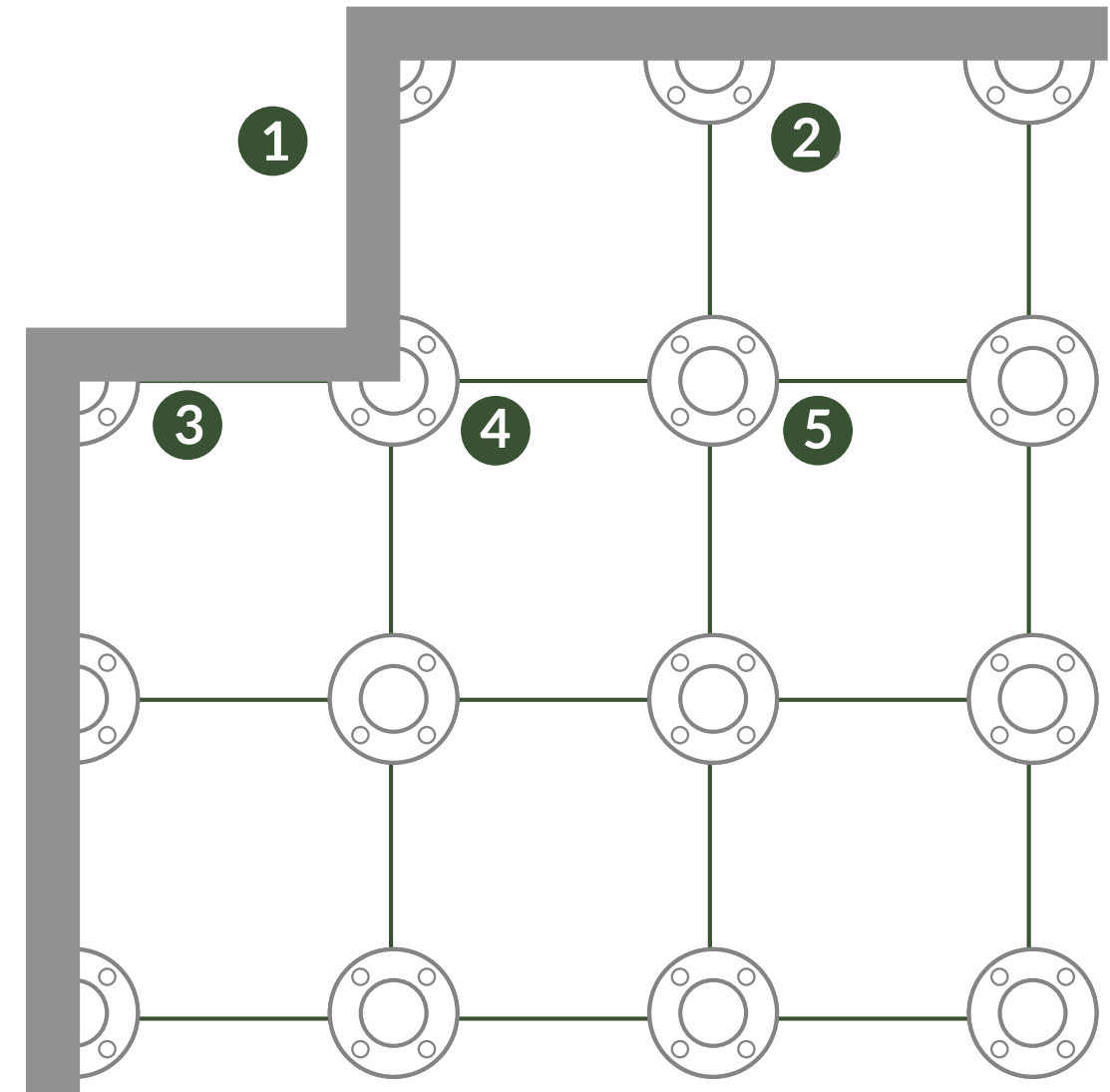

Set pedestals and tiles on top, adjusting each pedestal

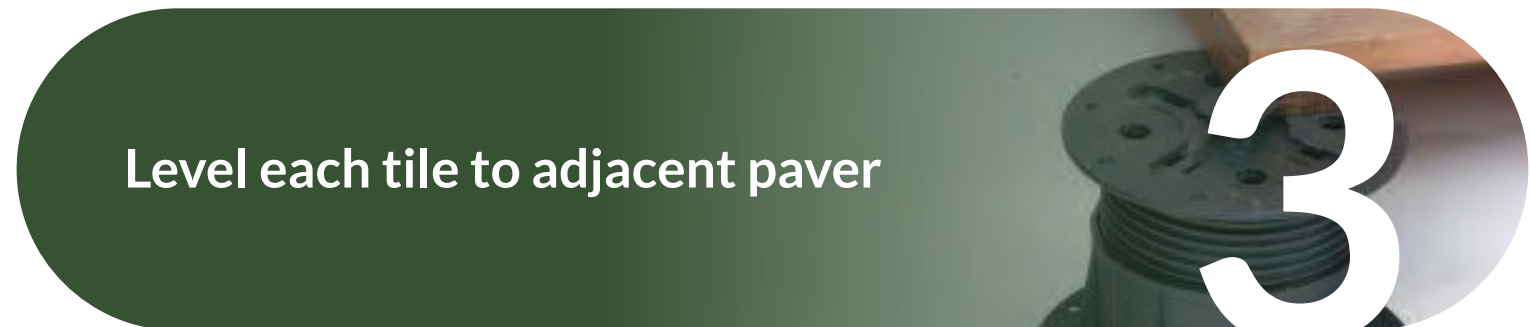

Level each tile to adjacent paver



Center pedestal or support tray for support if needed



Turn to adjust pedestal to final height



# PAVER GRATE

Paver Grate enhances impact resistance for porcelain pavers in pedestal applications. It also provides a structural surface for loose laid pavers on deck pedestals. Engineered to attach to the pedestals, the Paver Grate creates a stable and secure foundation and mitigates wind uplift resistance. For use with Paver Grate Fastening Kits.

## ADHERING PAVER TO PAVER GRATE PRIOR TO INSTALLATION

**STEP #1: Paver Grate Placement** Place paver grate on a clean, level surface, so that the solid side is face up and the waffle side is face down.

**STEP #2: Adhesive** Run a 1/4" diameter bead of Henry BES, 3M 550, or equivalent plastic and porcelain adhesive 3/4" from the edge and around the perimeter of the grate and in a cross pattern in the middle of the grate. **IMPORTANT:** For proper adhesion and performance, adhesive must be applied exactly as shown.

**STEP #3: Paver Placement on Paver Tray** Place the Paver squarely onto the adhesive side of the Paver Tray, carefully aligning by hand to make sure that the paver does not extend beyond any edge of the tray.

**STEP #4: Assembly Stacking** Repeat the first three steps to create a Paver Tray Assembly. Stack assemblies no more than (5x) assemblies high. Let them remain stacked for 2 to 4 hrs. to allow for the adhesive to cure, before handling.

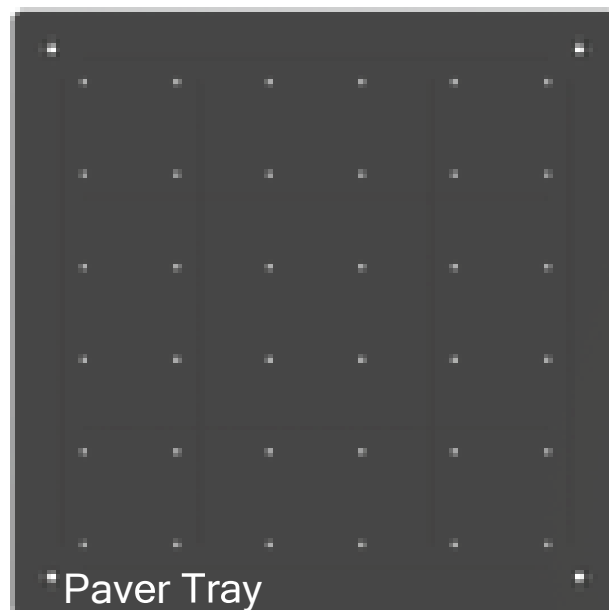
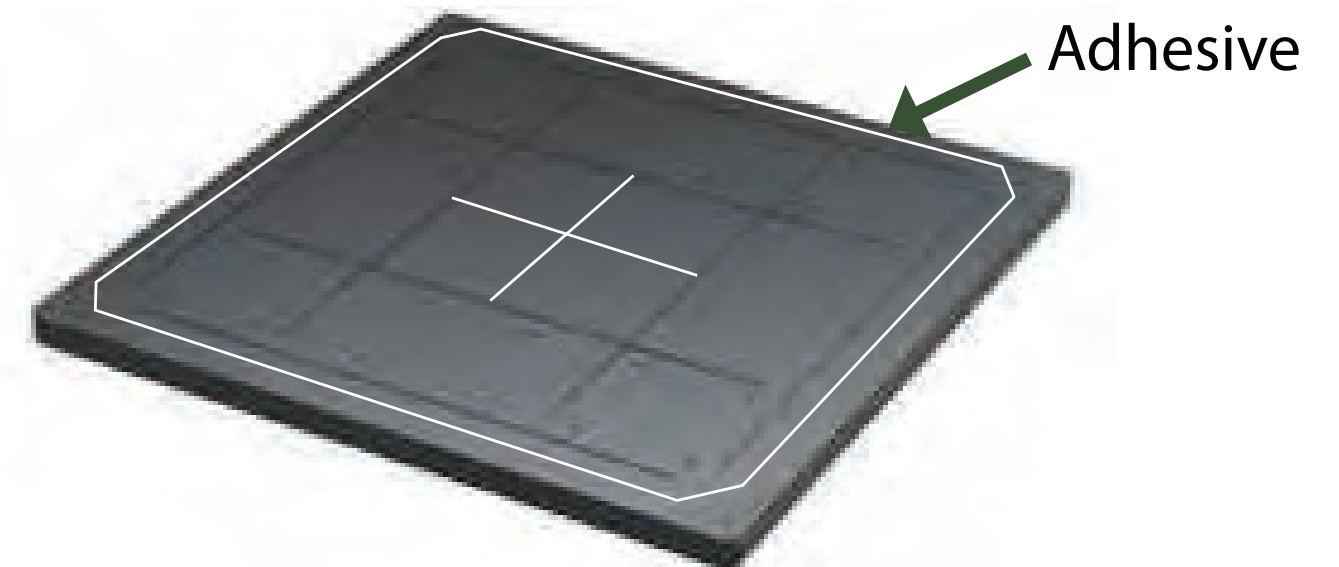
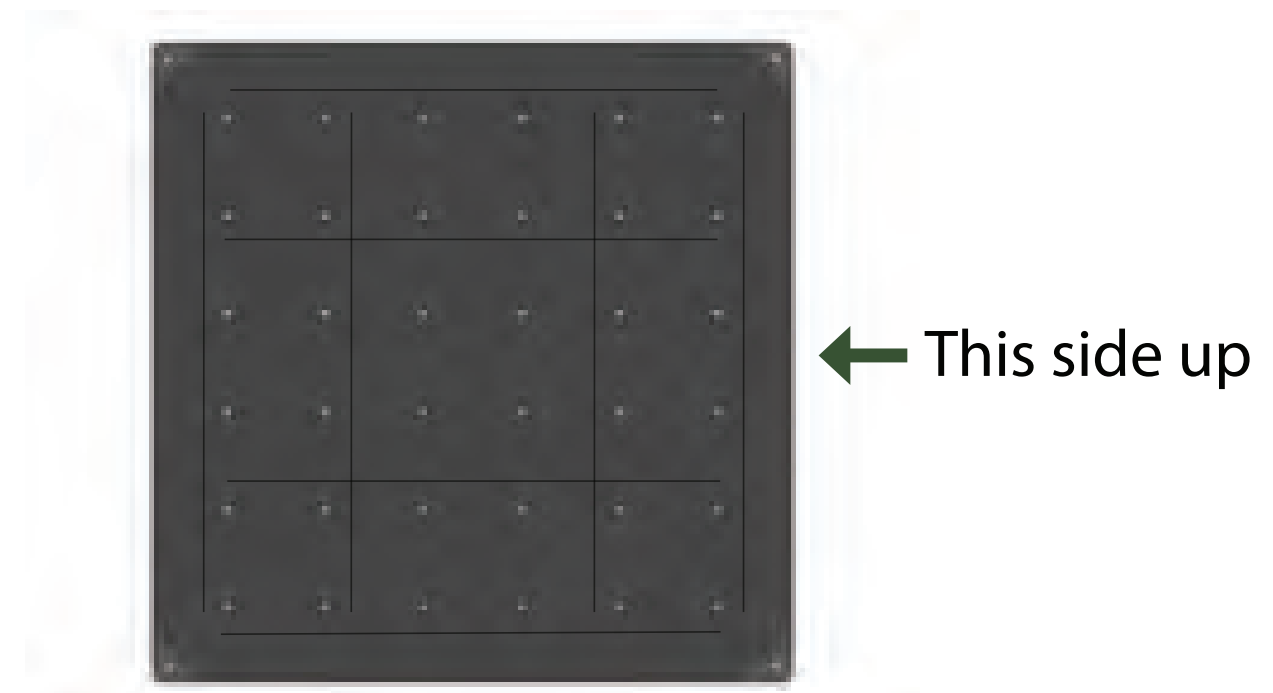

Paver Tray



Standard 2cm porcelain Paver

# Pedestal Supports

Adjustable Telescoping Supports

## What are EAD Adjustable Pedestals?

EAD Adjustable Pedestals are a heavy duty adjustable lightweight telescopic pedestal with an integrated slope bottom slope corrector manufactured from 100% recycled plastics. It is used to support pavers of any sort, beams and bearers in the construction of roof terraces, pedestrian walkways, roof gardens and platforms. Pedestals are adjustable in height from .5" - 36" inches in height native. The height may be increased to 48 inches using proprietary extenders as well as connecting rods to ensure maximum stability.

## Advantages

Pedestals reduce sound transmission and increases heat insulation. Bottom Rubber pads collect vibration and supply compression dampening like no other pedestal in the market. Unsightly services may be concealed within the cavity under the elevated platform, allowing easy access when required.

## Flexibility

Pedestals can be used with all of our structural pavers including porcelain paver tiles, hardwood deck tiles, FRP grating or standard precast concrete pavers. Pedestals can also be used to support built in benches and planters. A hollow internal core allows additional ballast such as cement infill to be used when required.

## Types of pedestal systems we offer

**Hybrid PVC with adjustable top**  
- great for high elevations or where you do not know the height range.

**Adjustable telescoping** for when you know the approximate range of finished floor height

**Fixed height stackable rubber pedestal** for low heights where you just need to accommodate drainage

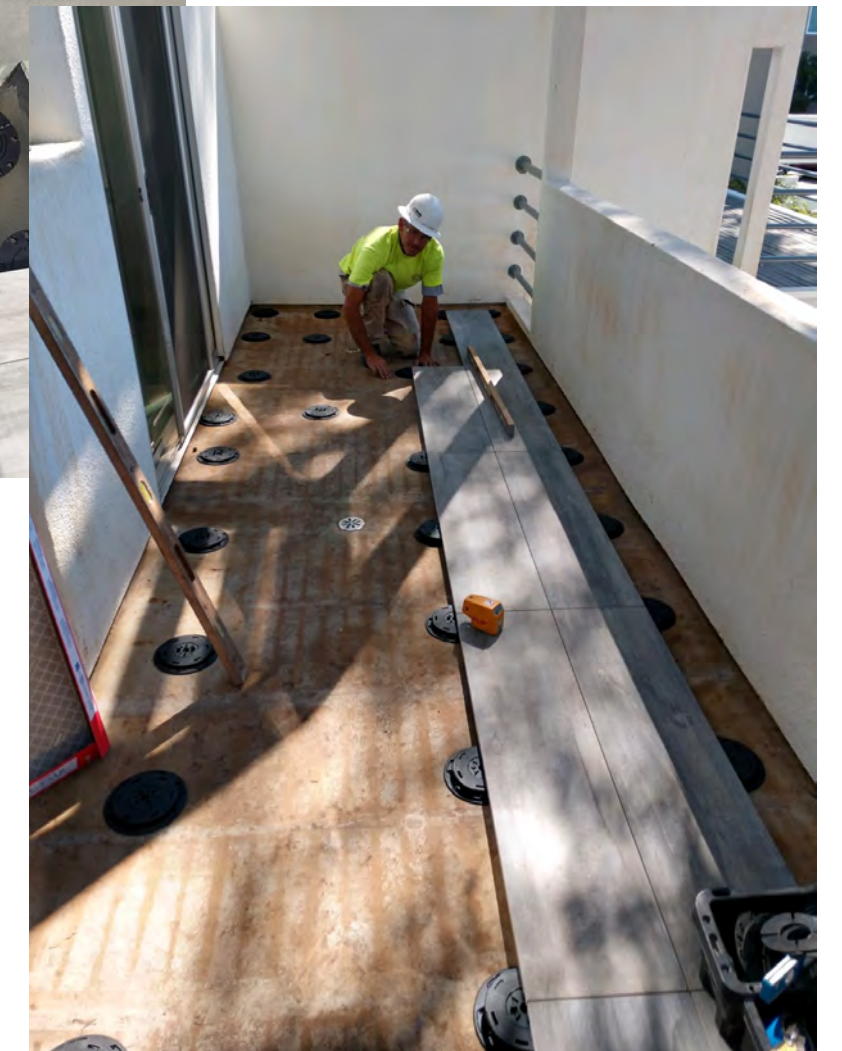
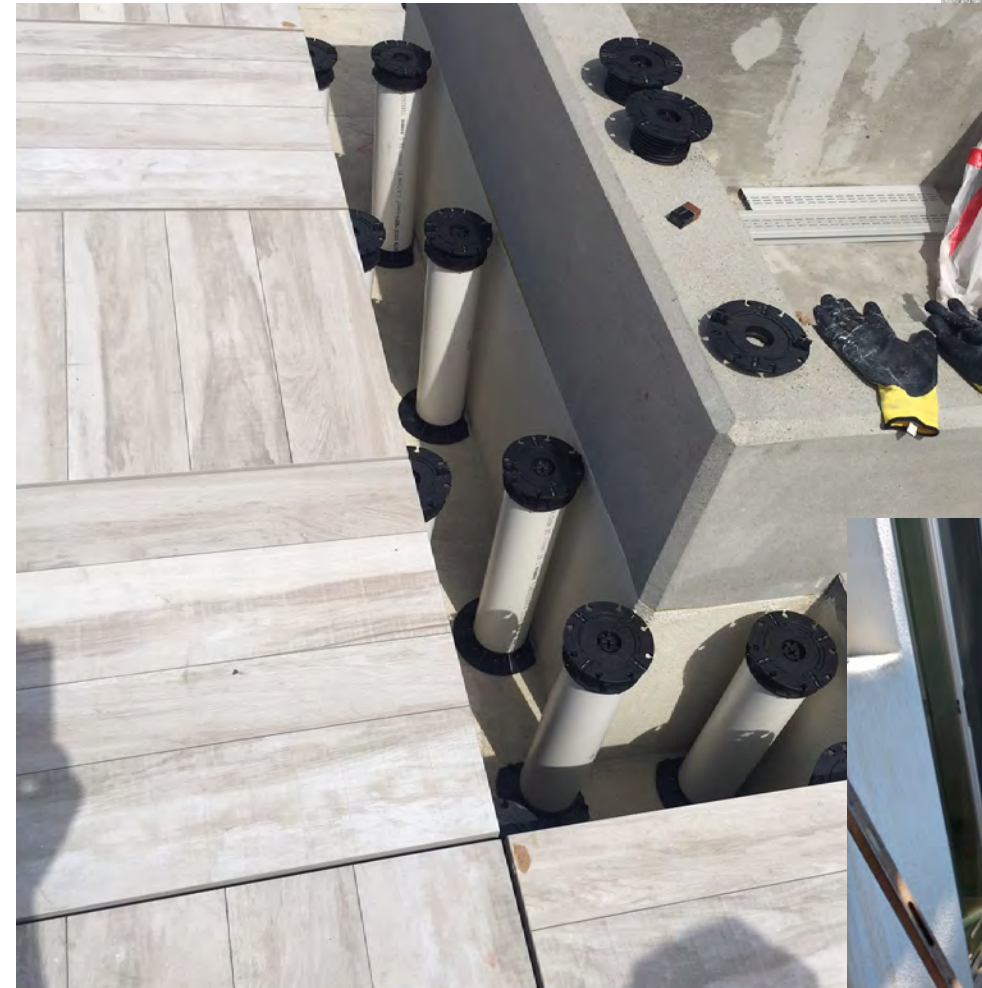

# Pedestal Supports

Telescoping Adjustable Supports

EAD pedestals are a height and slope-adjustable pedestal engineered by EAD which reduces material, construction and lifecycle costs. Height range of EAD is .5" to 36" , with 1/16th increments. Additional height of 45mm is obtained with the use of an extender.

EAD is used in areas such as balconies, swimming pool surrounds and courtyards, roof decks and ground level patios Accessories include bottom slope-correctors, spacer tabs, height extender, base plate and joist bearer holders.

## Advantages

- Low minimum height of 12mm
- Precise 1mm height adjustment
- Top and/or bottom slope correctors
- Easy to install, cost effective and lightweight
- Made from 100% recycled materials
- Supports Green Building certification

## Construction Benefits

Low minimum height is ideal for installations where other height-adjustable pedestals are generally too high to be used.

Eliminates need for bedding sand or cement screed, reducing the load burden on building structures.

It also reduces installation time and costs.

Joint sealants and/or grouting is rendered unnecessary and expansion and contraction of pavers do not result in unsightly cracks.

### High Compressive Strength

EAD pedestals with Extenders up to 119mm have a compressive strength of  $\geq 25$  kN.

### Supports Green Building Certification

EAD pedestals are manufactured from recycled materials which meets RoHS requirements.

**“Engineered to reduce material, construction and lifecycle costs.”**

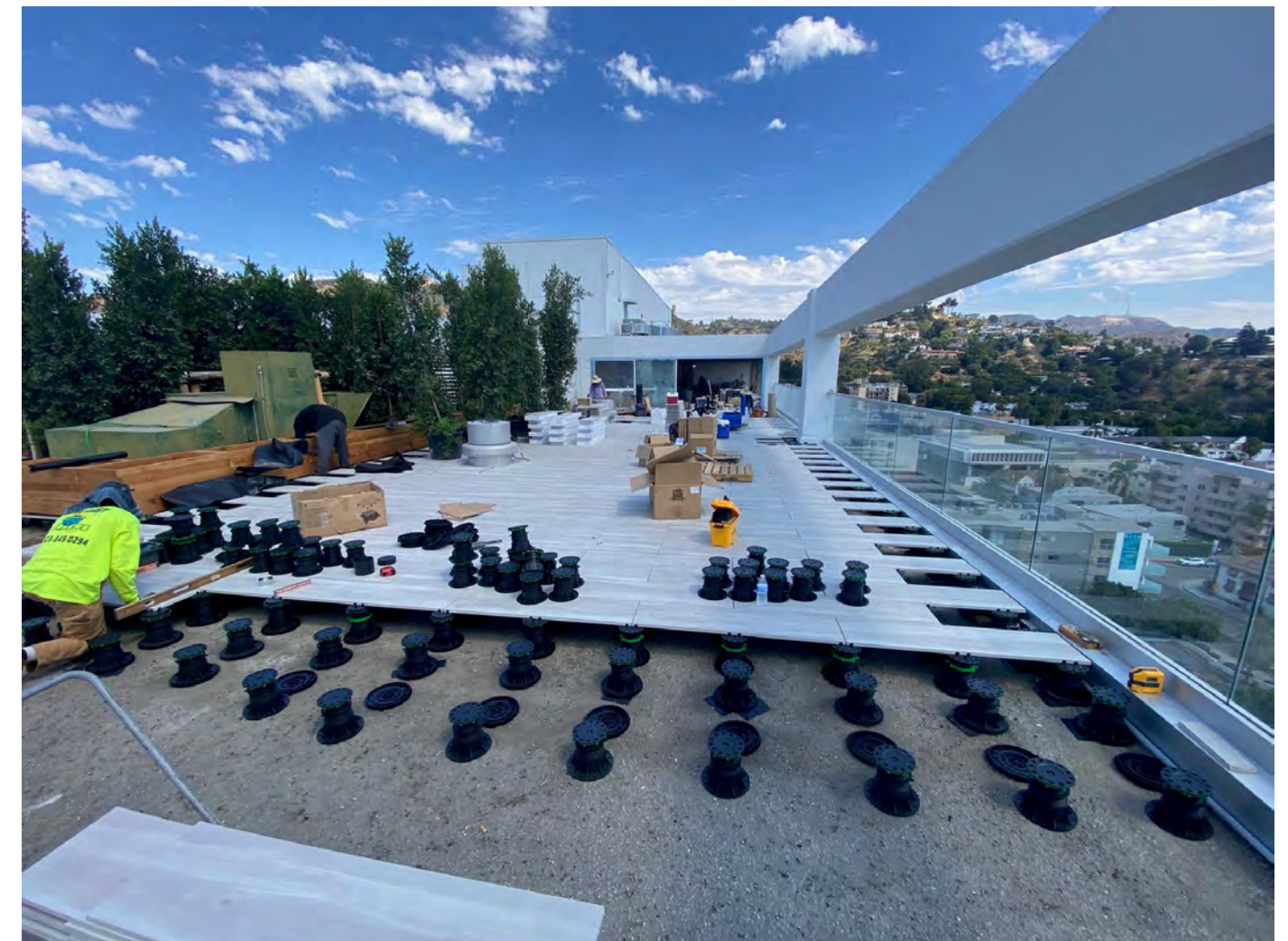
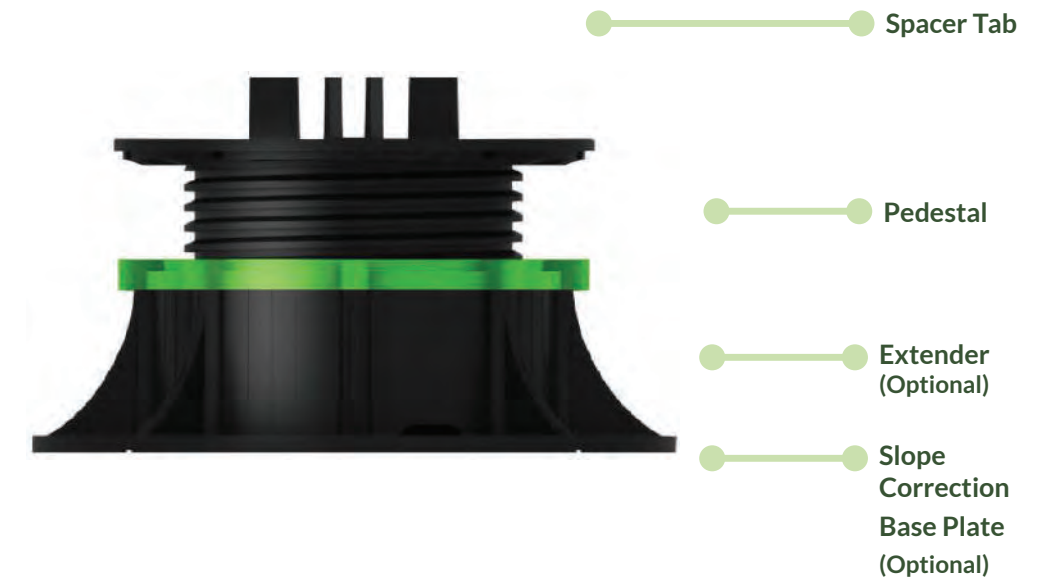



# Pedestal Supports

Adjustable Telescoping Supports

- Material:** Recycled Polypropylene 300 grams per extender
- Color:** Black
- Weight:** EAD .50 - 1.54 lbs. per unit
- Height Range\*:** .5" - 36"
- Dimensions:**
  - Head diameter 6.3"
  - Base diameter 8.1"
  - Extender height 3"
- Compressive Strength\*\*:** 3527.4 lbs.
- Slope Compensation:**
  - 5.94" onwards with extenders
  - 4.4" per extender
- Service Temperature:** -20C-120C
- Biological Chemical Resistance:** Unaffected by molds and algae
- Resistance:** Good resistance to alkali and bitumen



Slope Corrector

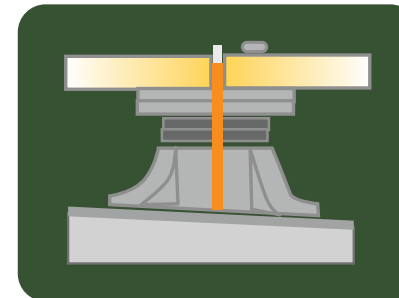

Slope connectors provide compensation of up to 5% on sloping surfaces and ensure pedestals remain fully upright.

Shims

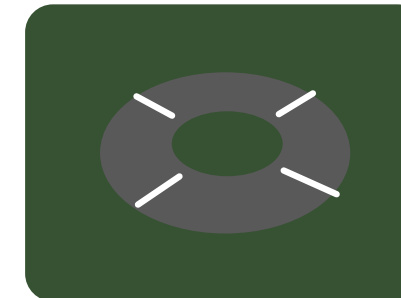

Slip resistant EPDM shims compensate for any slight difference in paver thickness and also provide a degree of shock and sound absorption.

Fixed Height Spacers

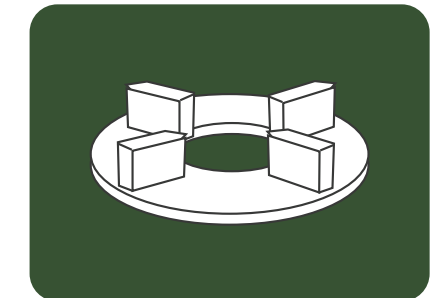

Low rise spacers 1/2"-3/4" high and sound absorption placed under the edge of the pavers compensate for slight irregularities when pavers are laid directly over concrete

# EAD Pedestal®

## Height Chart

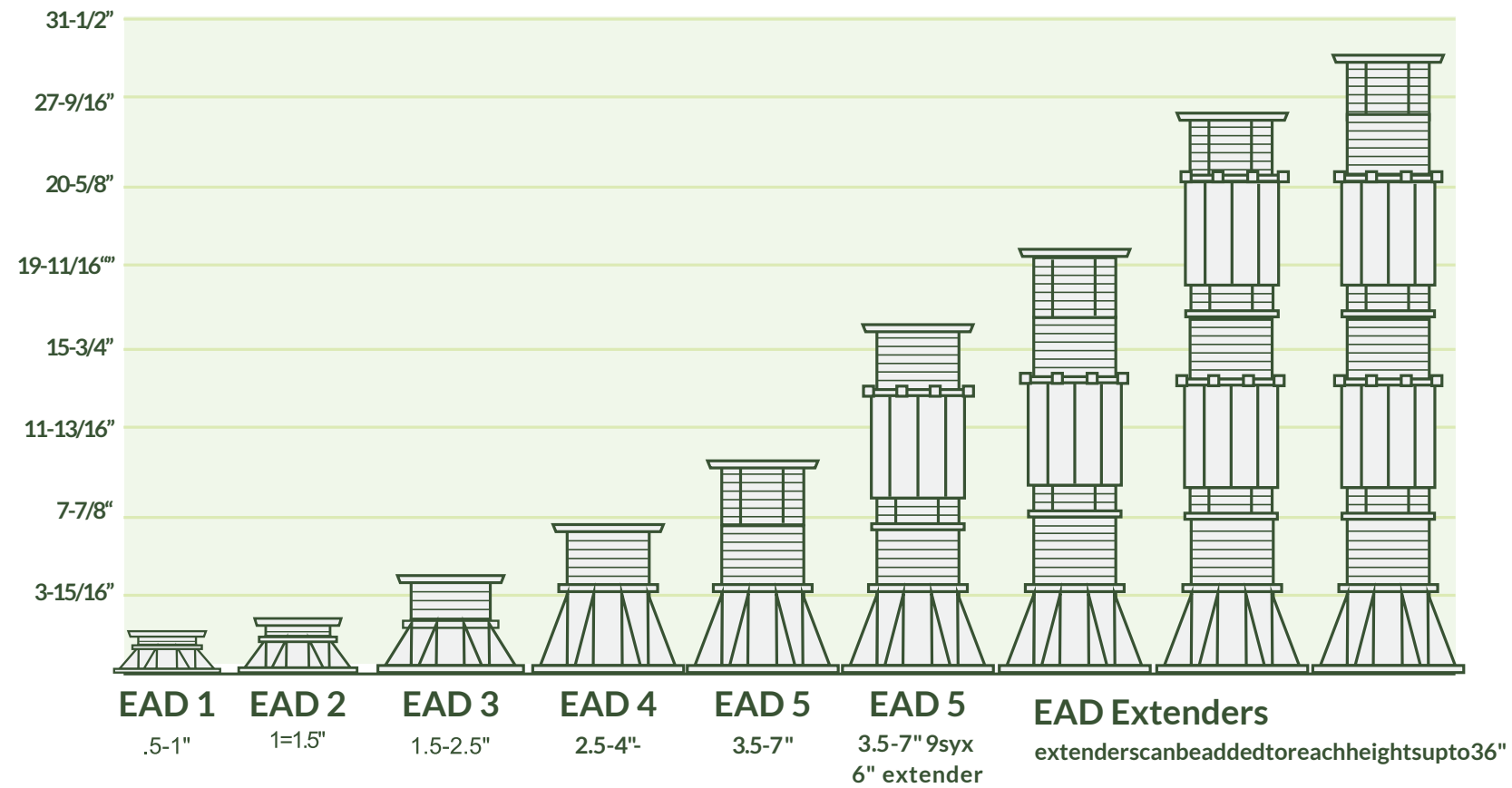

Types of Raised floors we offer depending on requirements or type of subfloor

### Fixed Height Raised Floor



### Adjustable Leveled Floor



### EAD 5 with extender



- Spacer Tab
- Slope Corrector (Optional)
- Pedestal
- Extender (Optional)
- Base Plate (Optional)



EAD®  
Model EA2

## Eco Arbor Designs

EAD Deck Tile Spec Sheet A. General Deck Pedestals and Tile Information

### 1.4 Delivery, Storage, And Handling by EAD and customer

- A.** Comply with Division 01 Section “Product Requirements.”
- B.** Comply with manufacturer’s ordering instructions and lead-time requirements to avoid construction delays.
- C.** Deliver materials in manufacturer’s original, unopened, undamaged containers packaging with identification labels intact.
  - 1.** Coordinate delivery and paving schedule to minimize interference with normal use of building adjacent to paving.
  - 2.** Unload pallets at job site in such a manner that no damage occurs to the product.
  - 3.** Porcelain Pavers once received at the job site are NOT RETURNABLE please make sure color and style is what was indicated on invoice and sample.
- D.** Protect stored materials from mud, dirt, and other foreign materials.
  - 1.** Store cleaners and sealers in accordance with manufacturer’s instructions for storage of said product.

### 1.5 Project Environment

- A.** There are no pedestal installation temperature restriction guidelines other than the practical considerations of working in any unsafe condition or inclement weather.
  - 1.** Do not install membrane when the ambient temperature is below 0°F.
  - 2.** Do not allow petroleum, grease, oil, solvents, vegetable or mineral oil, animal fat, etc. to come in contact with the waterproofing membrane, this includes deck tile sealers.
- B.** Deck supports specified are to be for used with pedestrian traffic only.
- C.** Pedestrian decks must be restrained by perimeter blocking or walls on all sides. Lateral movement greater than 1/8” is unacceptable and will be rejected.
- D.** Heavy Roof Top Features. Flat bottom features such as planters, heavy benches, water features, hot tubs, etc. always require individual support that is in addition to the deck pedestal system.
  - 1.** A minimum of one additional pedestal support must be installed for every 500 lbs. (or portion thereof) of static loading. These additional support pedestals must be installed directly under the decking and evenly spaced immediately below the feature locations. One additional pedestal must be placed under corner of any rectangular feature. In addition we would recommend an additional pedestal be placed in the center for any 2cm porcelain deck tile
- E.** All decks shall be designed to not exceed the design capacity of the pedestal.
- F.** The substrate immediately below the pedestals shall provide positive drainage.
- G.** In the case of decks over roofing substrates, roof systems must meet local building code and be in accordance with the NRCA recommended good construction practices. Only roofing manufacturer approved systems shall be used.





**H.** Decks over roofing and waterproofing:

1. EAD Pedestal Installation: EAD pedestals must be installed on surfaces with a minimum 40 psi bearing capacity.
2. Installation: EAD pedestals must be supported by a surface that provides a minimum 30 psi bearing capacity.
4. Subject to acceptance by owner, mock-up may be retained as part of finished work.

**Eco Arbor Designs**

EAD Deck Tile Spec Sheet A. General Deck Pedestals and Tile Information

**1.6 Warranty ECO DECK Tiles and EAD Pedestals**

**A.** At project closeout and upon request, EAD can provide to the Owner or Owners Representative, an executed copy of the manufacturer’s standard document outlining the terms, conditions and limitations of their limited warranty against manufacturing defect for a period of three (3) years ( wood tiles) 1 year Porcelain Pavers

**B.** It is the responsibility of the Contractor installing the product listed in this section to coordinate warranty requirements with any related sections or adjacent Work. Notify the Architect immediately of any potential lapses or limitations in warranty coverage.

**C.** For use with pedestrian traffic only – Never use EAD pedestals to support decks that have wheeled, motorized or equipment traffic.

**D.** Decks should be restrained on all sides and not have lateral movement in excess of 1/8”.

**E.** Warrant that Work of this Section will remain free from defects in labor and materials used in accordance with Division 01 General Conditions of this project for five years from the date of Substantial Completion.

**2.1 Project Environment**

**Manufacturer/Importer:**

Eco Arbor Designs Inc  
2525 San Clemente Ave Suite A  
Vista, CA 92084

**ph:** 888 359 4435, **fax:** 831 515 5054,

**email:** info@ecoarbordesigns.com

**web:** www.ecoarbordesigns.com

**Applications/Scope**

**A.** Furnish and install a complete adjustable deck support system with a maximum cavity height of up to:

1. EAD Pedestals maximum cavity height 22 inches (610 mm).
2. EAD Pedestals with Elmich extender system for excess height installations in the range of 1.5-40 inches.
3. Deck supports are not designed for supporting deck that carry vehicular traffic or equipment including but not limited to snow removal equipment, ATV’s, forklifts, or any motorized vehicles.

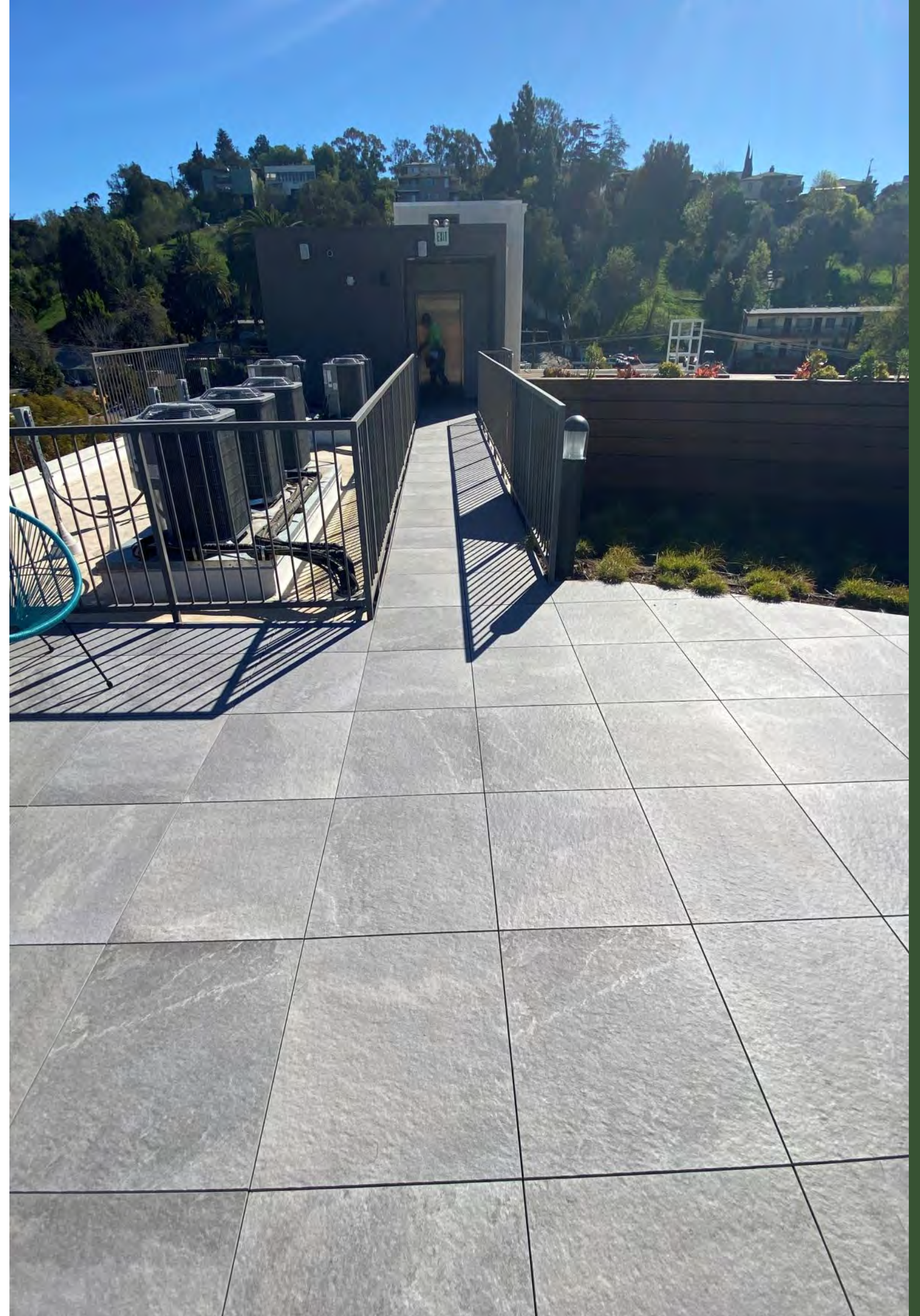



**B.** Consult EAD and the Project Engineer regarding the following:

- 1.** When spacer tab condition or design requires spacing between decking tiles or concrete pavers other than the standard spacing required by the manufacturer. Spacers are available in 4mm and 6mm gauge.
- 2.** When considering use for other than a raised decks (e.g. interior floors, stairs, etc.).
- 3.** When the required pedestal height exceeds the safe limits as determined by the Manufacturer.
- 4.** When pedestal load capacity exceeds the maximum listed.
- 5.** When anticipating installation of any items with excess weight on top of the deck.

**C.** Installation of EAD ECO DECK Tiles (IE: Ipe deck tiles, 2cm porcelain and stonedeck tiles)

### **3.1 Examination**

**A.** Verify that all surfaces, membrane(s), protection board, insulation, drains, are free from dirt, oil, grease or any deleterious substances and debris which may prevent installation, drainage, and stability of the paving slab installation.

**B.** Verify that roof deck has at least 1-1/2 percent but no more than 2 percent slope to drains.

**C.** Do not begin paving work until such conditions have been corrected and are ready to receive leveling materials.

### **Eco Arbor Designs**

EAD Deck Tile Spec Sheet A. General Deck Pedestals and Tile Information

### **3.2 Preparation**

**A.** Establish accurate lines, levels and pattern.

**B.** The substrate surface that will receive the deck supports must be well compacted (on grade) and structurally capable of carrying the dead and live loads anticipated.

**C.** The substrate must be clean and free of projections and debris that could impair the performance of the pedestals or the total deck system.

**D.** Decks over roofing and waterproofing

**E.** Decks on Grade: verify that installation conforms to section 1.7I of this specification.

**F.** Installation requirements vary for each individual project site. Deck materials used, pattern, grid layout, starting point, and finished elevation should be shown on plan view shop drawings which have been prepared and approved by the designer, installing contractor and/or owner.

**G.** Once a starting point and the finished elevation of the deck surface have been determined, the support system elevation (finished elevation minus deck material thickness) is established and marked around the perimeter using a transit "torpedo" water level or laser leveling device.





### 3.3 Installation of pedestals and surface deck tiles, EAD ECO DECK, 2cm Porcelain pavers or wood pavers

- A.** Install in accordance with manufacturer's instructions.
- B.** If required, place a 1 or 2mm rubber shim where each pedestal is to be laid out to cushion the base against the waterproof surface.
- C.** Next, a deck support must be placed where each measured grid line meets the perimeter. Remove two (2) spacer tabs in line with one another on top of each deck support placed around the perimeter. Remove all four (4) spacer tabs at corners. Any combination of this can be achieved to space the tiles where less than 4 spacer tabs are needed.
- D.** Adjust each deck support to the desired height required, fine tuning can be done once the surface material of EAD ECO DECK wood tiles , 2CM porcelain deck tiles or Stonedek tiles are laid on top.
- E.** On larger decks, it is recommended that pedestals be pre-sorted and pre-set to the proper elevation and placed in position prior to the installation of pavers or tiles. This is called the layout.
- F.** As the deck supports located along the grid lines are loaded with pavers or tiles, fine vertical adjustment can be made by rotating the base or bottom of the deck support. Clockwise rotation of the pedestal base will raise the bearing surface and the deck. Counter-clock- wise rotation will lower the top bearing surface.
- G.** EAD pedestals have built in height limit indicator. When pedestal is fully extended, height limit indicator can be felt with the hand, indicating the maximum height of the pedestal. Do not extend pedestal beyond the height limit indicators. Do not exceed maximum height listed on pedestal; use the next size pedestal in the series. Never over extend any pedestal
- H.** Slight irregularities in decking panel thickness can be compensated for by using one to two mm rubber shim segments. Place on top of the pedestal, under the corner(s) of the decking tile or paver. Use no more than two (2) shims on top of the pedestal and always adhere 1/4 wedges with construction adhesive.
- I.** Spriapave and EAD Series Slope Compensation: 1. The ESP and EAD Series has integrated leveler disks that compensate for up to 5% grade in 1% increments. Additional slope compensation can be added by placing a bottom slope correct in addition to the top slope corrector.

#### Eco Arbor Designs

##### EAD Deck Tile Spec Sheet A. General Deck Pedestals and Tile Information

- 1.** Shims may be used in multiples, whole or segmented, and placed under the base to level the deck support.
- 2.** Under a pedestal: All shims under a pedestal must be adhered to each other or the pedestal (NOT to the roofing membrane) with construction adhesive. Shim no more than 1 and 2mm beneath each pedestal. The use of Jiffy Seal double sided adhesive rubber flashing paper in 1mm thickness can be very useful for a floating base layer between pedestal and roofing membrane or similar surface
- 3.** On top of a pedestal: Use no more than 4 rubber shims.

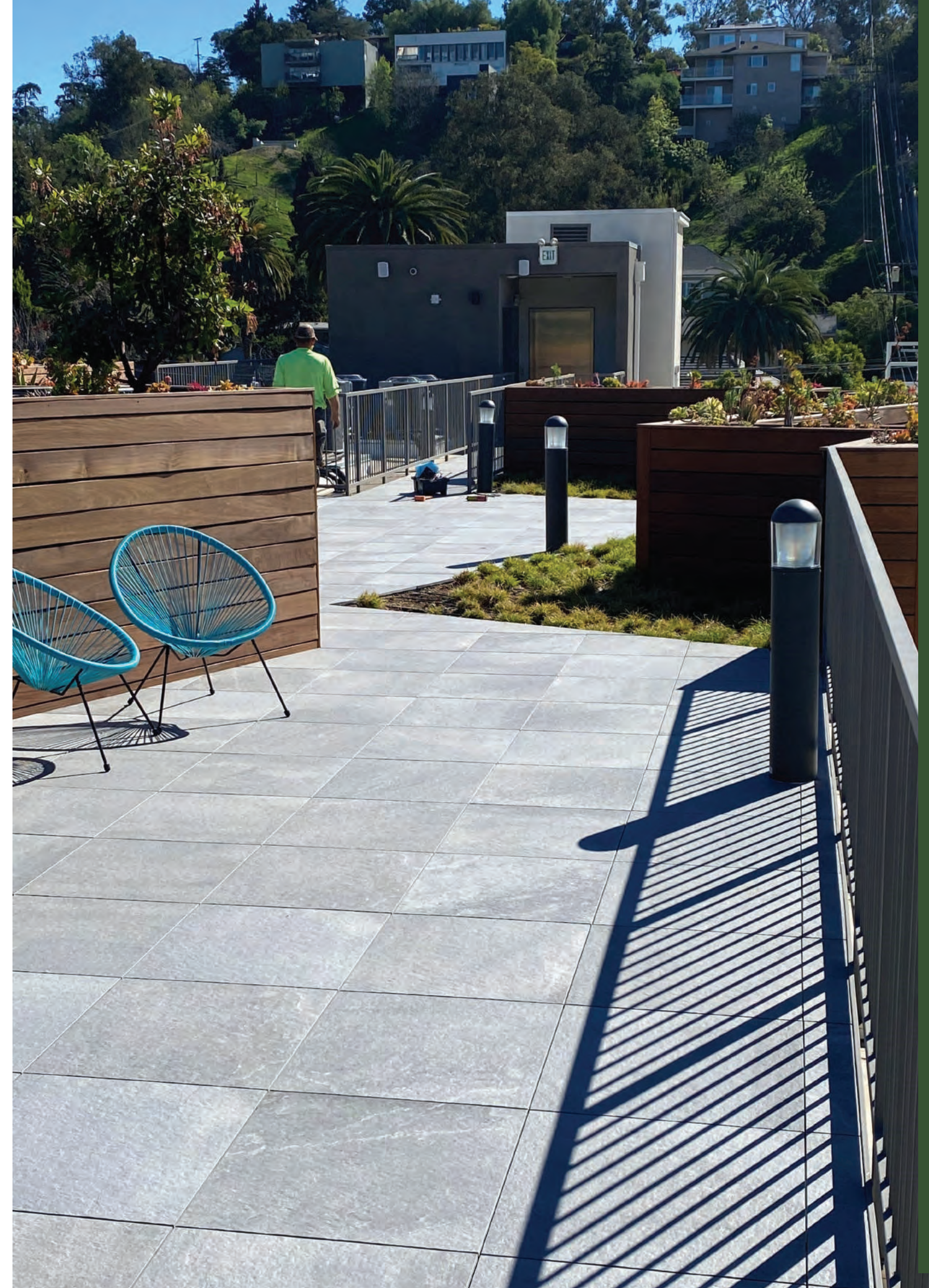



### 3.4 Deck Support Placement And Final Adjustment

- A.** Deck supports and the deck surface panels must be placed as the manufacturer directs in these written instructions. Use of labor saving devices, such as paver lifters and pedestal turning keys is recommended
- B.** Pedestals are designed to be rotated for final slight adjustment when pedestals are fully loaded. Deck supports should be leveled in each succeeding row as the installation proceeds. Final height adjustment or maintenance is easily made by simply rotating the base in a clockwise or counter-clockwise direction to raise or lower the deck surface material.
- C.** Additional sections of shims may be used and should be available for regular maintenance. Shims may be used in multiples or placed under the base or on top the pedestal to level the deck support.
- D.** On top of pedestal: Use construction adhesive to use adhesive for sections of shims. Construction adhesive is not required when using whole shims on top of a pedestal.
- E.** Beneath a pedestal: Use a small amount of construction adhesive for adhesion of sections of shims and/or whole shims to each other or to the pedestal. Unless specified to do so, DO NOT use construction adhesive for pedestal or shims to insulation, roofing or waterproofing membrane.

**3.5 Any area of a deck that is not restrained by a parapet or foundation wall must be 'boxed-in' and contained. The deck panels can shift if all sides are not adequately restrained. Perimeter containment located at the outside of the deck must be installed to provide restraint. No movement should be allowed at the perimeter of the deck system greater than 1/8".**

### 3.6 Field Quality Control

- A.** Inspect often during installation to assure that grid spacer lines are being maintained in a straight and consistent pattern and that deck panels or pavers are level and not rocking.
- B.** Confirm that deck pedestal height does not exceed the specified height for the EAD Series:
- C.** 40 inches maximum pedestal height.
- D.** Unless otherwise specified in writing to allow for expansion, inspect to assure that all paver spacing between tiles and at perimeter containment does not exceed a 1/8". Particular attention should be made to assure that all pedestrian entry or access points to the deck are level and that the deck surface tiles are not randomly raised or uneven creating a hazard.

### Eco Arbor Designs

EAD Deck Tile Spec Sheet A. General Deck Pedestals and Tile Information

### 3.7 Protection

Protect installed products until completion of project, we usually recommend EAD ECO DECK tiles are installed post paint and staining of other materials in the area.

### 3.8 Immediately Following Installation

- A.** The Owner, or the Owner's Agent, shall carefully inspect the deck system to be positive that:
  - 1.** There are no shakes or wobbling of tiles, that each tile is supported properly.
  - 2.** There is no more than 1/16th to 1/8th " spacing between any deck panels and at all sides of the deck perimeter.

4. There is no ballasting rock used to fill in any perimeter voids.
5. There is no 'rocking' of deck panels as foot traffic is applied to the surface decking.
6. All required spacer tabs are in place and visible.

### 3.9 Routine Maintenance And Care

**A.** Installer and/or Architect has a duty to instruct the deck owner about performing routine maintenance of the deck. Check for rocking pavers and adjust or shim immediately. Substrates can settle and pedestals may have to be readjusted. Failure to do so can cause a tripping hazard. Periodically check spacer tabs and immediately replace broken tabs to limit deck movement. Make sure the edge restraint stays intact and structurally sound.

For regular cleaning of porcelain pavers we recommend the use of a mild alkaline detergent mixed with water.

For more stubborn stains we recommend the use of acid based cleaners such as FILA Cleaner or FILA PS87 is recommended. This may also be used after initial installation to remove any marks from transport.

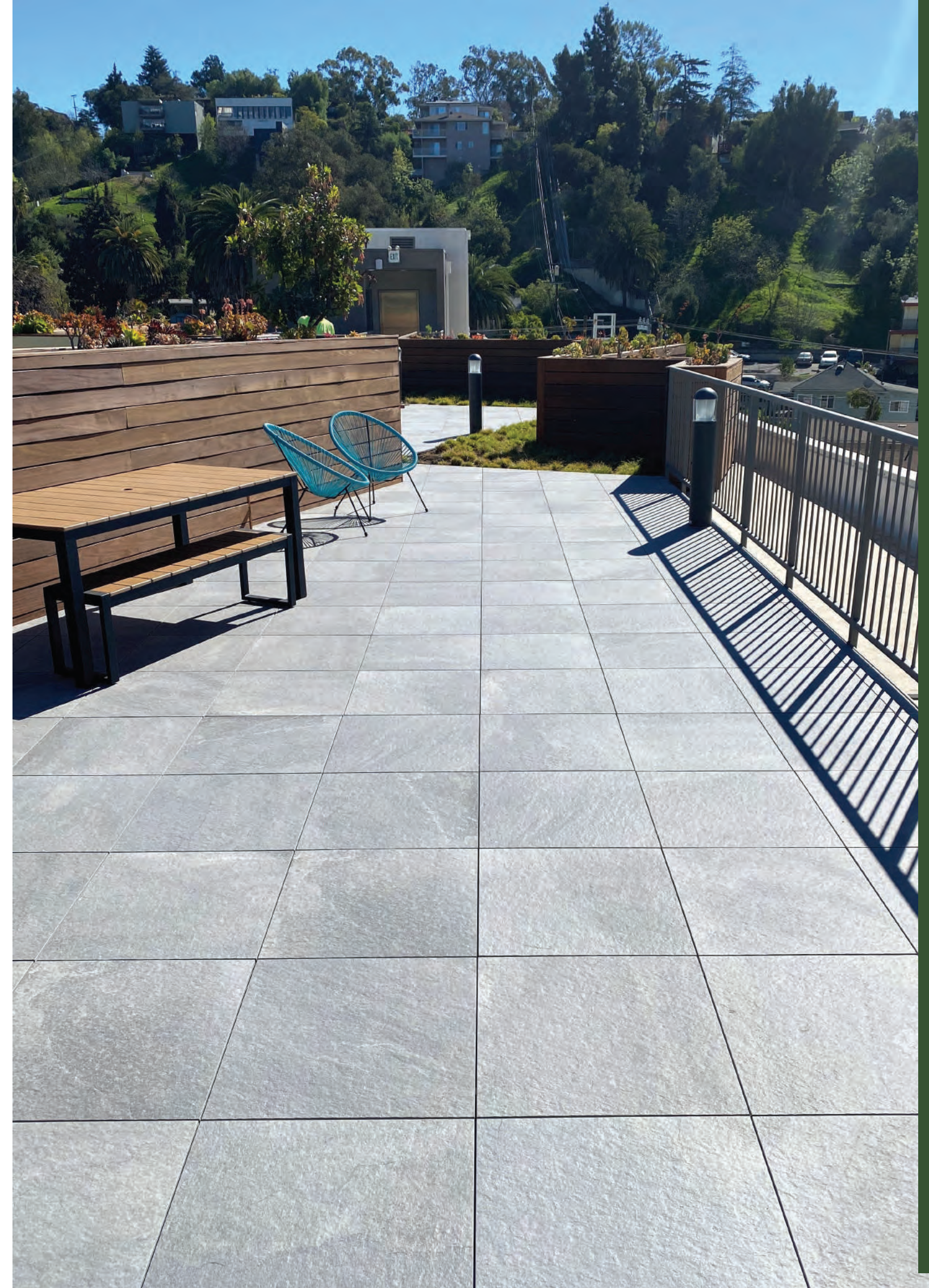

# Contact Information

## ECO ARBOR DESIGNS

Innovators of modular roof decking and flooring. We have been manufacturing and importing some of the finest raised floor systems in the world since 2005

## Corporate Office

Eco Arbor Designs  
2525 San Clemente Ave,  
Vista CA, 92084  
Toll Free 888 335 8453

Direct Northern California **831 359 4435**

Direct Southern California **858 914 2423**

VISIT US ONLINE AT  
[www.ecoarbordesigns.com](http://www.ecoarbordesigns.com)

EMAIL US AT  
[INFO@ecoarbordesigns.com](mailto:INFO@ecoarbordesigns.com)

## Warehouse and distribution centers

ECO ARBOR DESIGNS WEST COAST  
**Orange / ECO ARBOR DESIGNS**

**15300 Desmon Drive, La Mirada, CA 90638**

ECO ARBOR DESIGNS EAST COAST

SDS Global Logistics  
21 Spring Street  
West Orange, NJ 07052



ECO ARBOR DESIGNS